

ELECTRIC SUBMERSIBLE SEWAGE PUMPS



Ranges
MX, V, VX, K
Discharge Size
DN 80–DN 150



High Performance in Waste Water Pumping

HOMA submersible waste water and sewage pumps operate worldwide in numerous kinds of domestic, municipal and industrial applications. Decades of experience in the design and manufacturing of submersible pumps plus uncompromising attention to quality in every detail and strict monitoring of production quality ensure the utmost reliability and long service life of all **HOMA** products.



Flexible system-components for problem-free installation

HOMA combines efficiency, safety, high quality and robust design with a flexibility that allows the individual optimization of every project realization:

Pumps for various types of application and installation, a complete program of installation equipment including pipes, valves, pump pits from concrete or composite materials, electric control and monitoring systems. With this range **HOMA** can provide a tailor-made solution for every waste water pumping application.

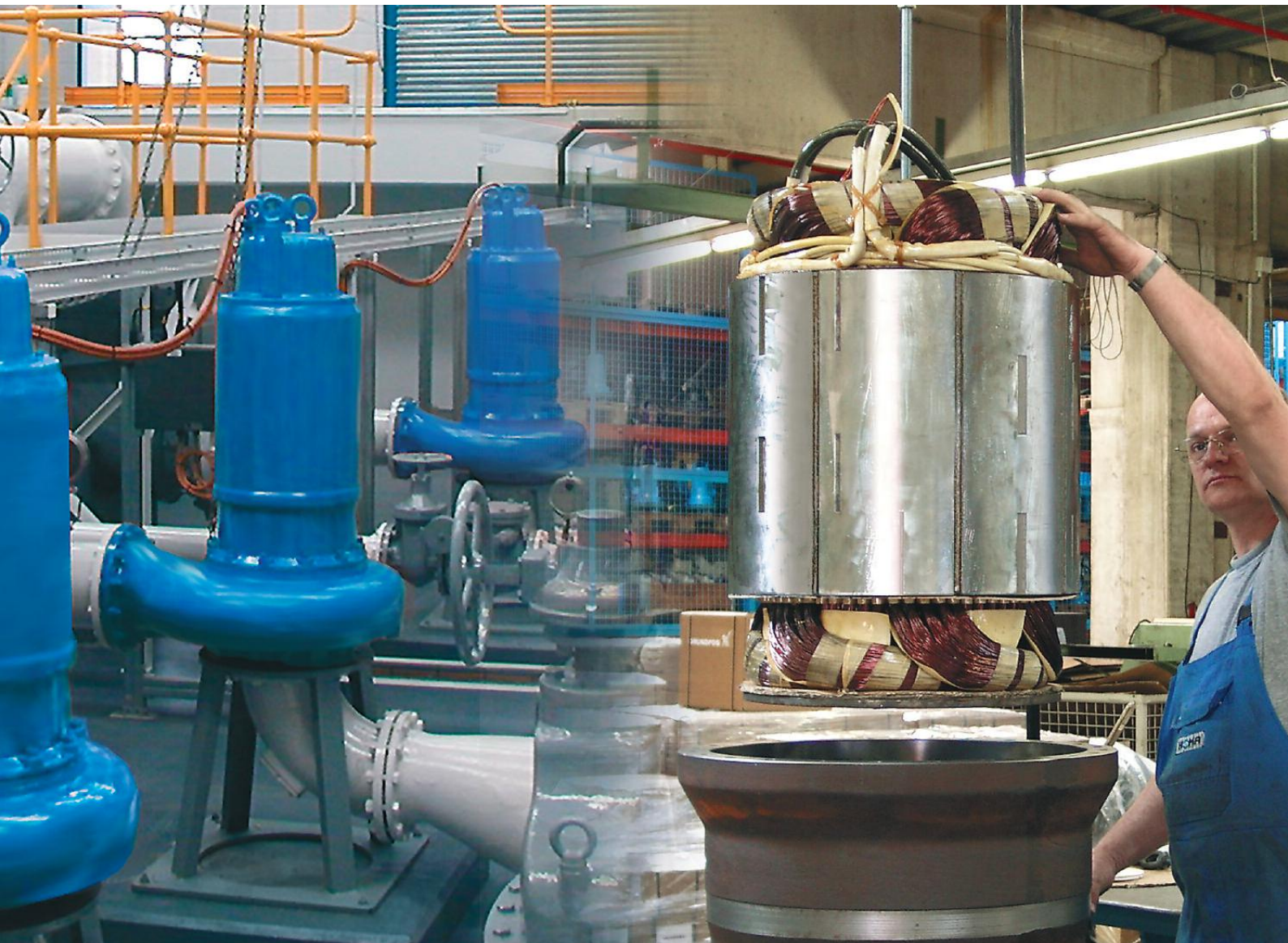

The reliability of fully automatic operation

HOMA waste water pumping stations feature fully automatic control and monitoring. Reliable liquid level control systems of various types (float switch, pneumatic, ultrasound or electronic systems) are available to secure reliable pump operation at minimum energy consumption. All possible fault factors like shaft seal condition, temperatures, moisture or power supply can be automatically monitored and transferred to various alarm systems.

Higher Performance to meet every Challenge

Various challenges – individual solutions: **HOMA** submersible wastewater pumps are designed for pumping sewage, sludge, effluents or surface water, including liquids containing a large proportion of solid or fibrous matter. They are installed in domestic, municipal, industrial and agricultural pumping applications.



The right installation for every pump station

Permanent wet well installation

Submerged autocoupling guide tube system for automatic connection and disconnection of the pump from the pipework from outside the sump. All maintenance or repair work can be done outside the sump. Back in operating position, the weight of the pump ensures leak-proof discharge connection.

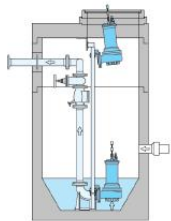

Transportable wet well installation

Submerged pump mounted on a ring base stand for temporary, service or emergency operation. Discharge connection with pipe or hose.

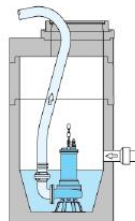

Permanent dry well installation, vertical or horizontal

Flood-proof installation for pump stations with separate collection sump. Fixed flanged connection of suction and discharge pipe.

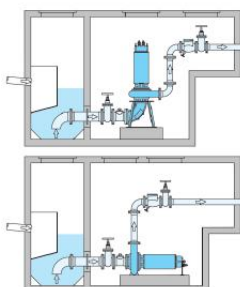

Operating conditions

The motors are designed for continuous operating duty (S1) at maximum 15 starts per hour. In addition to a fully submerged motor housing in wet well installation, a jacket cooled motor-variant is available for S1 operating with a non-fully submerged motor or for dry well installation.

Pumps with enclosed single-channel impellers are designed for intermittent operation, normally in automatic level-controlled wet or dry well sump installations. They are also suitable for limited continuous operation, as in storm water retention tanks. Vortex or enclosed multichannel impeller pumps are also designed for unlimited continuous operation, such as industrial water supply. In this case a low motor speed should be chosen (4- or 6-pole).

Ranges and Models

Motor selection

Motor speed:

For the standard hydraulic ranges, the motors are designed with the following speeds:

- 2900 rpm = 2-pole
- 1450 rpm = 4-pole
- 960 rpm = 6-pole

Voltages:

All specified data relate to an operating voltage of 400 V/3 Ph, 50 Hz. Different voltages are available on request.

Type of starting:

The motors are supplied as standard:

- up to 3,5 kW (P2) for DOL starting
- above 3,5 kW (P2) for star-delta-starting

On request all motors are available for operating with frequency converter or soft starter device.

Explosion protection:

In addition to the standard version, all motors are available explosion proof according to

Ⓔ II 2 G Ex c d [e] [ib] IIB T4, T3.

Dry well variant:

Besides the version for submerged operation, all pumps are also available for dry well or non-submerged operation. Motor cooling is provided by a cooling jacket, using either the pumped liquid or a closed circuit coolant circulation (model U or L).

Motor monitoring:

All motors are supplied with temperature sensors in the winding, bi-metallic sensors (standard) or PTC sensors (on request).

- Motors for wet well installation (without cooling jacket): Available as C-version (see pump type code) with oil chamber seal condition monitoring probe and – for motors with cable junction chamber – moisture sensor in junction chamber)
- Motors with cooling jacket: Supplied as standard with oil chamber seal condition monitoring probe. Additional monitoring devices (bearing temperature, stator room moisture) on request.

Hydraulic selection

Discharge and suction flange

- DN 80
- DN 100
- DN 150

Reducing adapters for different auto-coupling system and valve dimensions are available.

Impellers:

A range of different impeller designs are available to provide optimum performance and reliability with various liquids and operating conditions

Impeller spherical clearance:

The pumps are available with impeller spherical clearances from 80 mm to 100 mm according to pump range.



MX Enclosed single channel impeller
For liquids containing impurities and sludge with solid particles or long fibres.



K Enclosed multi channel impeller
For liquids containing impurities and sludge with solid particles.



V(X) Vortex impeller
For liquids containing a high level of impurities or fibrous matter and containing gas.

Pump type code:

Pump	2	4	48 -	Motor	(U)	6	4	(C)	(EX)
MX				T					
Impeller design	Discharge size:	Spherical clearance:	Impeller diameter	Motor frame size:	Jacket cooled:	Motor power (coded)	Speed:	only for motors without jacket cooling. With:	Explosion proof motor
MX = Enclosed single channel V(X) = Vortex K = Enclosed two channel	1 = 80 mm 2 = 100 mm 3 = 150 mm	(mm : 25) 3 = 80 mm 4 = 100 mm	(mm : 5) e. g. 48 = 240 mm	C, D, T, P, F, G	Jacket cooled motor for non-submerged installation U= Open circuit pumped liquid cooling L= Closed circuit liquid cooling		2 = 2-pole (2900 rpm) 4 = 4-pole (1450 rpm) 6 = 6-pole (960 rpm)	- oil chamber seal condition monitoring probe - moisture sensor in junction chamber (if exists)	

Design – Proven Quality in Detail

More quality in design and materials – less maintenance and failures

Quality can be measured – **HOMA** submersible waste water pumps are characterized by the robust design, generous dimensioning and high quality materials of all components.

Materials

Motor housing	Cast iron EN-GJL-250 ¹⁾
Pump housing	Cast iron EN-GJL-250 ¹⁾
Impeller	Cast iron EN-GJL-250 ^{1) 2)}
Wear rings	Bronze ¹⁾
Motor shaft	Stainless steel
Mechanical seals	Silicon-carbide / Silicon-carbide
Motor cooling jacket (model U)	Stainless steel
Seals and O-rings	NBR (Perbonane) ³⁾
Cable	H07RN-F (PLUS) ⁴⁾

¹⁾ also available in stainless steel

²⁾ also available in bronze

³⁾ also available from FPM (vitone)

⁴⁾ screened cable on request

1 Discharge

With DIN/ANSI flange DN 80, DN 100 or DN 150 (PN 10)

2 Non-clogging, high efficiency impellers

With large spherical clearance.

Available:

- Enclosed single channel impeller with replaceable wear ring
- Enclosed multi channel impeller with replaceable wear ring
- Vortex impeller

3 Shaft seals

Two independently working silicon-carbide mechanical seals in tandem-arrangement.

4 Oil chamber

Separate large oil chamber, lubricating and cooling the mechanical seals, forming an extra safety and inspection element. Additional electronic seal condition monitoring probe on request.

5 Motor

Three-phase electric motors, with 2-, 4- or 6-pole motor speed. Insulation class H (180 °C), degree of protection IP 68

Explosion protection

All models available with explosion proof motors according to

⊕ II 2 G Ex c d [e] [ib] IIB T4, T3

6 Motor cooling

Motors for submerged operation are cooled by the surrounding liquid. For dry well or non-submerged operation, motors are available with a cooling jacket, providing a cooling circulation of water from the pump volute (model U). Alternatively, a closed circuit liquid cooling system is available without directly using the pumped liquid for the cooling circuit, providing the heat exchange through a contact surface between heat exchange chamber and pump chamber.

7 Thermal sensor (bi-metal)

Embedded in the motor winding. PTC sensors available on request.

8 Moisture monitoring in stator chamber

Available on request

9 Shaft bearing

Maintenance-free, prelubricated ball bearings.

10 Temperature monitoring of the shaft bearings

Available on request.

11 Cable junction chamber

Separate junction chamber standard from 22 kW 4-pole, below on request.

12 Electronic moisture sensor in junction chamber

Available on request.

13 Pressure sealed, strain relief cable entry

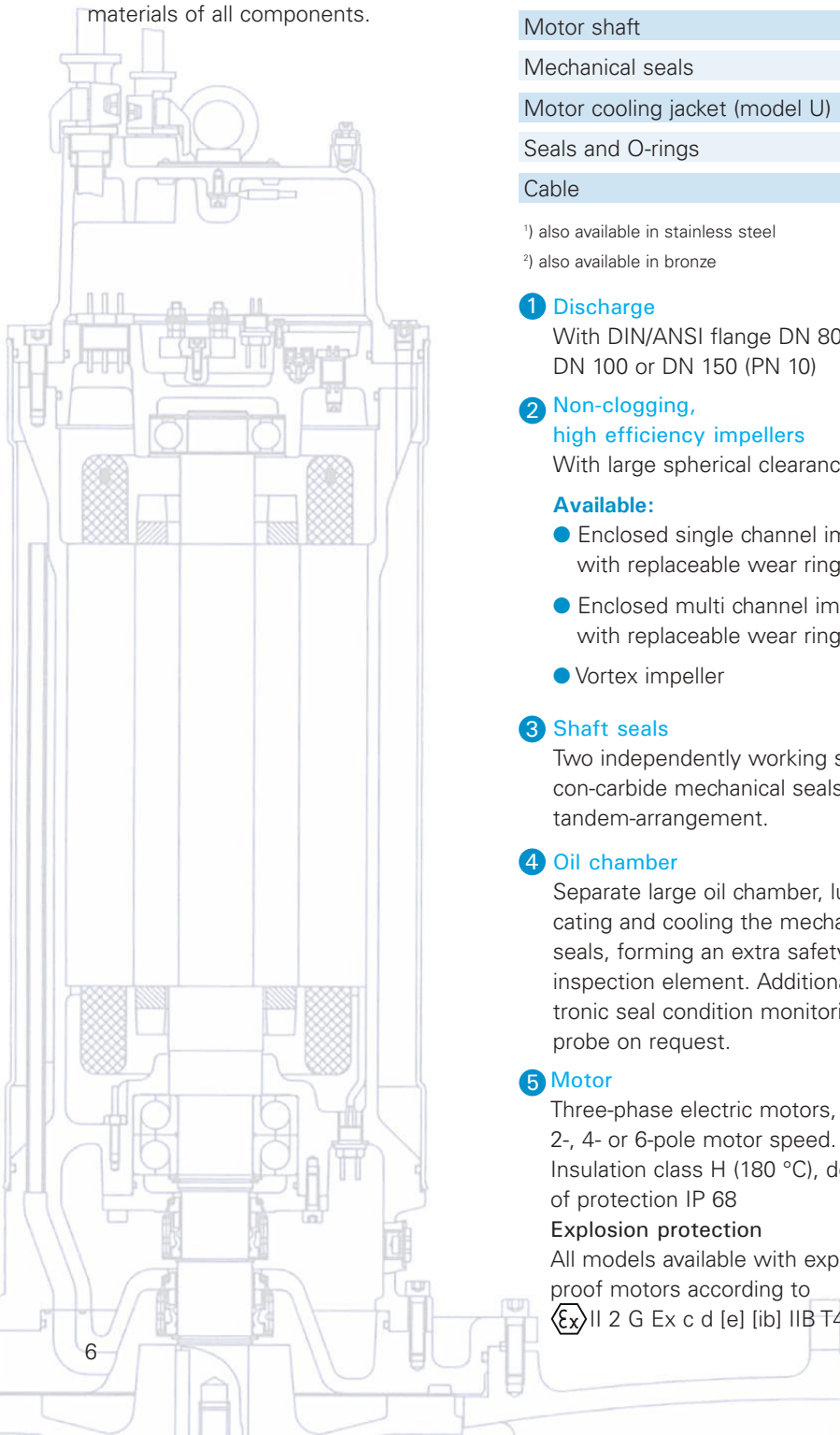

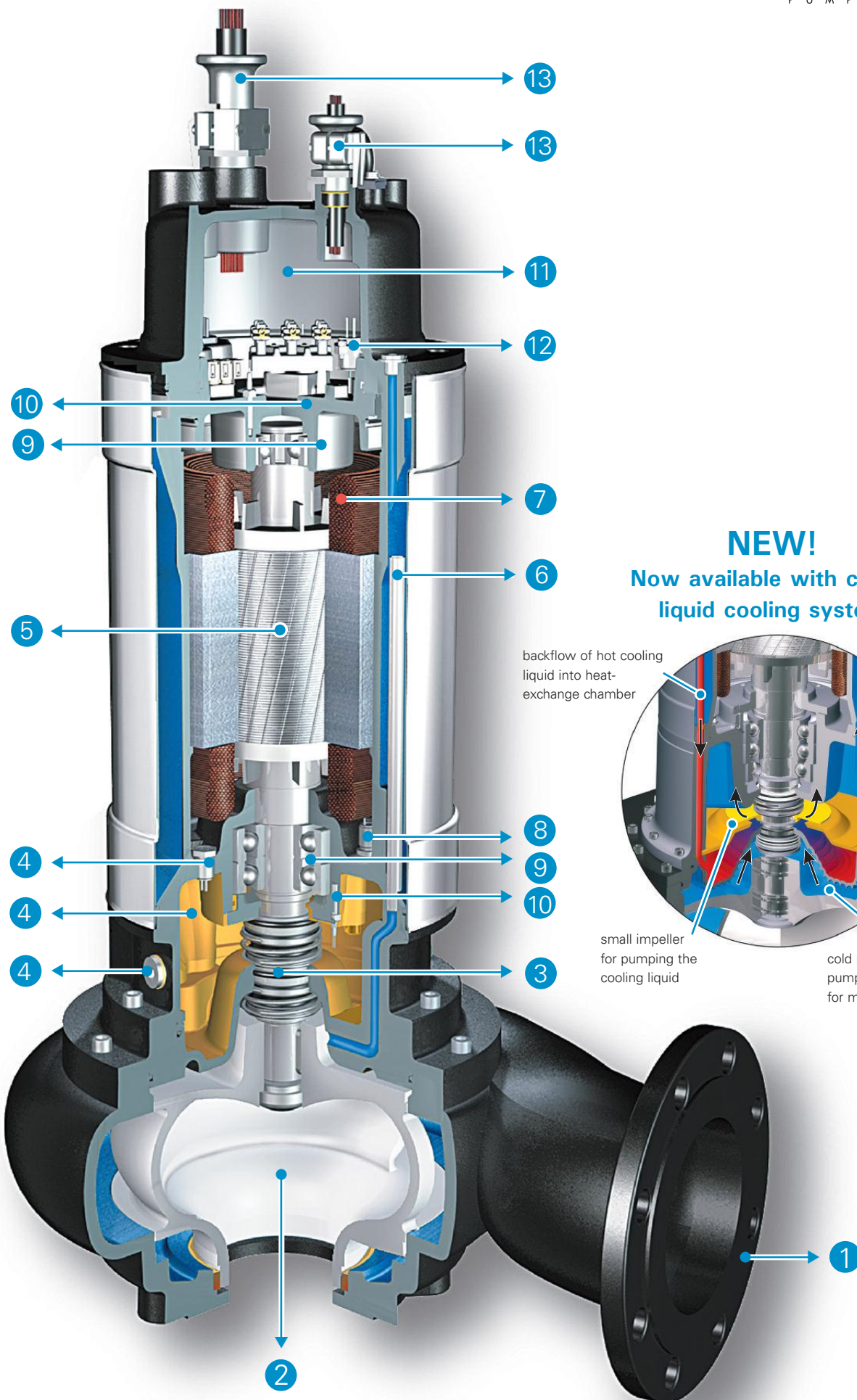

NEW!
Now available with closed
liquid cooling system

backflow of hot cooling
liquid into heat-
exchange chamber

inflow of cold cooling
liquid into motor
jacket chamber

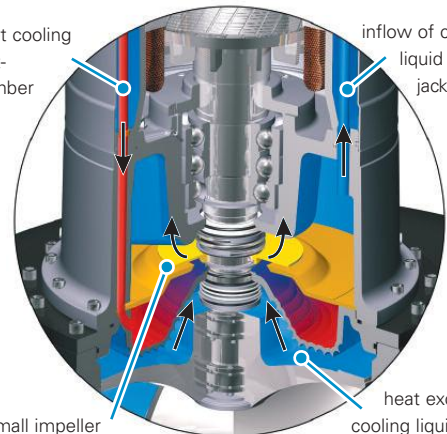

small impeller
for pumping the
cooling liquid

heat exchange of
cooling liquid with
cold pumped liquid trough
pump flange, spiral-shaped
for maximum surface

Pump ranges selection chart



MX 13... -2 pole

DN80

Enclosed single channel impeller
80 mm Ø
Spherical clearance

2900 rpm

[see page 10](#)

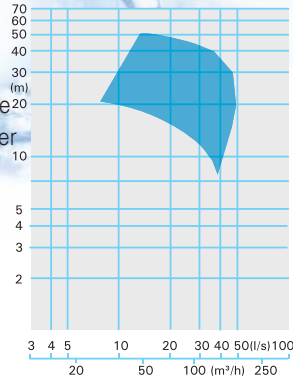

MX 13... -4 pole

DN80

Enclosed single channel impeller
80 mm Ø
Spherical clearance

1450 rpm

[see page 11](#)

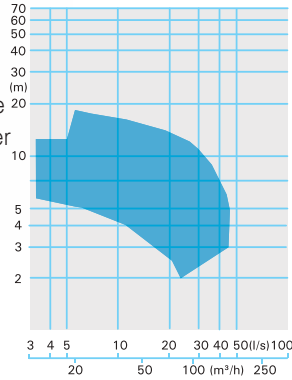

MX 13... -6 pole

DN80

Enclosed single channel impeller
80 mm Ø
Spherical clearance

960 rpm

[see page 12](#)

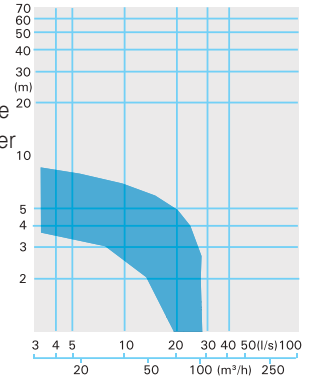

MX 23... -2 pole

DN100

Enclosed single channel impeller
80 mm Ø
Spherical clearance

2900 rpm

[see page 15](#)

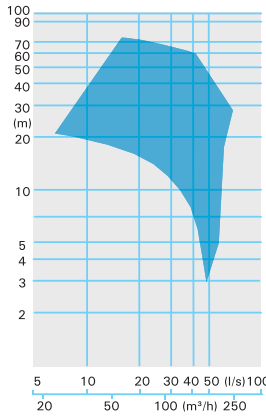

MX 23... -4 pole

DN100

Enclosed single channel impeller
80 mm Ø
Spherical clearance

1450 rpm

[see page 16](#)

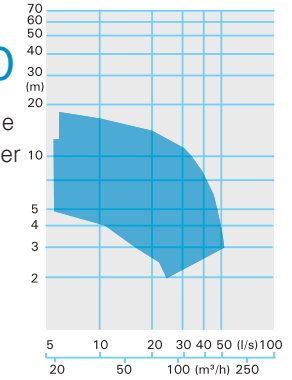

V 23... -2 pole

DN100

Vortex impeller
80 mm Ø
Spherical clearance

2900 rpm

[see page 17](#)

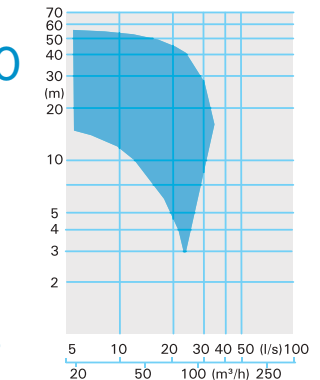

MX 24... -4 pole

DN100

Enclosed single channel impeller
100 mm Ø
Spherical clearance

1450 rpm

[see page 19](#)

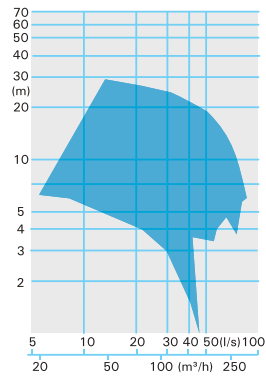

MX 24... -6 pole

DN100

Enclosed single channel impeller
100 mm Ø
Spherical clearance

960 rpm

[see page 20](#)

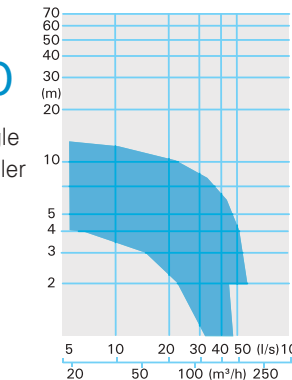

VX 24... -4 pole

DN100

Vortex impeller
100 mm Ø
Spherical clearance

1450 rpm

[see page 21](#)

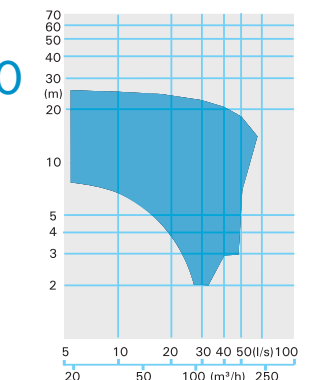

MX 34... -4 pole

DN150

Enclosed single channel impeller
100 mm Ø
Spherical clearance

1450 rpm

[see page 22](#)

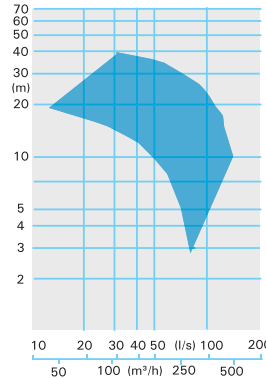

MX 34... -6 pole

DN150

Enclosed single channel impeller
100 mm Ø
Spherical clearance

960 rpm

[see page 23](#)

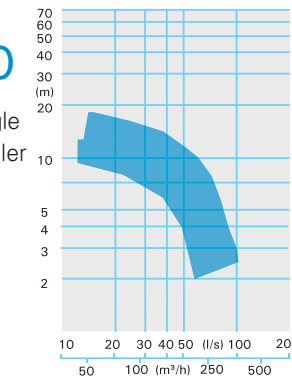

K 33... -4 pole

DN150

Enclosed two channel impeller
100 mm Ø
Spherical clearance

1450 rpm

[see page 24](#)

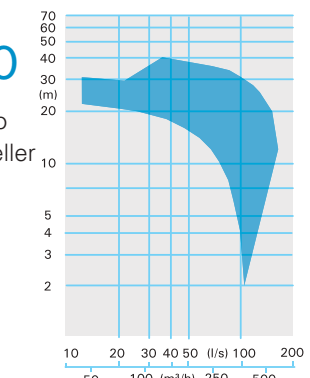



V 13... -2 pole

DN80

Vortex
impeller
80 mm Ø
Spherical
clearance

2900 rpm

see page 13

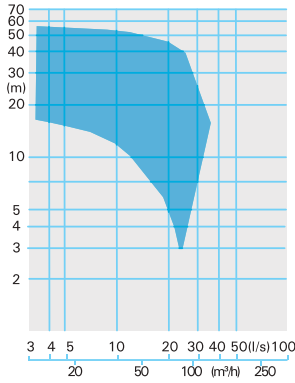

V(X) 13... -4 pole

DN80

Vortex
impeller
80 mm Ø
Spherical
clearance

1450 rpm

see page 14

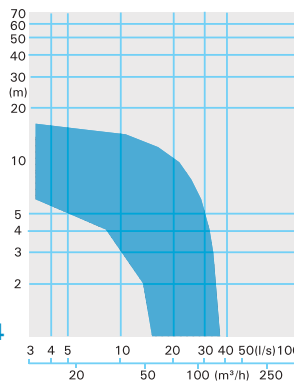

V(X) 23... -4 pole

DN100

Vortex
impeller
80 mm Ø
Spherical
clearance

1450 rpm

see page 18

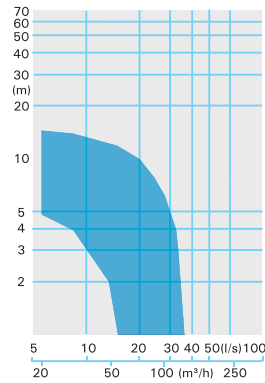

K 33... -6 pole

DN150

Enclosed two
channel impeller
80 mm Ø
Spherical
clearance

960 rpm

see page 25

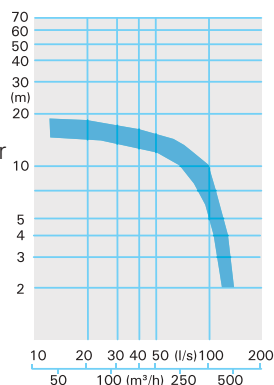

VX 34... -4 pole

DN150

Vortex
impeller
100 mm Ø
Spherical
clearance

1450 rpm

see page 26

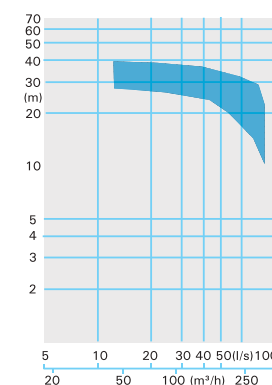

VX 34... -6 pole

DN150

Vortex
impeller
100 mm Ø
Spherical
clearance

960 rpm

see page 27

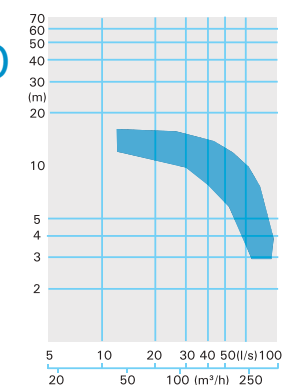

DN80 - MX13...-2 pole



Enclosed single channel impeller
80 mm Ø
Spherical clearance
2900 rpm

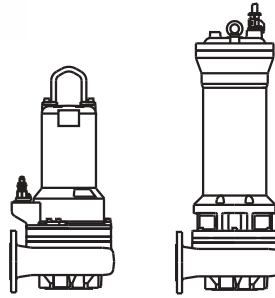

Performance curves

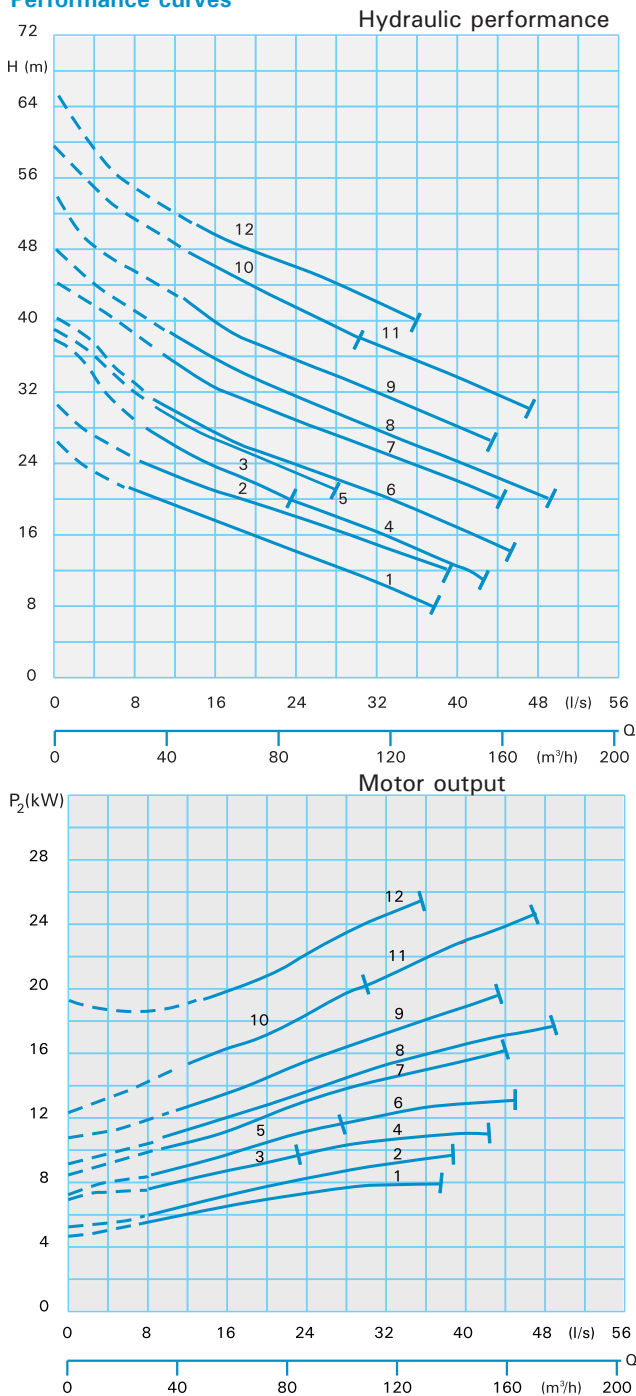

Technical data

Standard- and Explosion-proof model – Wet well installation						
Curve No.	Pump type	Motor input P ₁ (kW)	Motor output P ₂ (kW)	Rated current I _N (A)	Weight standard (kg)	Weight Ex (kg)
1	MX1330-T72(C)(Ex)	11.0	9.5	18.8	104	104
2	MX1331-T72(C)(Ex)	11.0	9.5	18.8	104	104
3	MX1335-T72(C)(Ex)	11.0	9.5	18.8	104	104
4	MX1335-T82(C)(Ex)	13.0	11.5	22.2	109	109
5	MX1336-T82(C)(Ex)	13.0	11.5	22.2	109	109
6	MX1336-P92(C)(Ex)	22.0	19.6	36.9	179	191
7	MX1337-P102(C)(Ex)	22.0	19.6	36.9	179	191
8	MX1338-P102(C)(Ex)	22.0	19.6	36.9	179	191
9	MX1339-P102(C)(Ex)	22.0	19.6	36.9	179	191
10	MX1341-P102(C)(Ex)	22.0	19.6	36.9	179	191
11	MX1341-P122(C)(Ex)	28.0	25.4	46.3	199	211
12	MX1344-P122(C)(Ex)	28.0	25.4	46.3	202	214

Standard- and Explosion-proof model – Dry well installation						
Curve No.	Pump type	Motor input P ₁ (kW)	Motor output P ₂ (kW)	Rated current I _N (A)	Weight standard (kg)	Weight Ex (kg)
1	MX1330-TU72(Ex)	11.0	9.5	18.8	109	109
2	MX1331-TU72(Ex)	11.0	9.5	18.8	109	109
3	MX1335-TU72(Ex)	11.0	9.5	18.8	109	109
4	MX1335-TU82(Ex)	13.0	11.5	22.2	114	114
5	MX1336-TU82(Ex)	13.0	11.5	22.2	114	114
6	MX1336-PU92(Ex)	22.0	19.6	36.9	191	203
7	MX1337-PU102(Ex)	22.0	19.6	36.9	191	203
8	MX1338-PU102(Ex)	22.0	19.6	36.9	191	203
9	MX1339-PU102(Ex)	22.0	19.6	36.9	191	203
10	MX1341-PU102(Ex)	22.0	19.6	36.9	191	203
11	MX1341-PU122(Ex)	28.0	25.4	46.3	211	223
12	MX1344-PU122(Ex)	28.0	25.4	46.3	214	226



Enclosed single channel impeller

80 mm Ø

Spherical clearance

1450 rpm

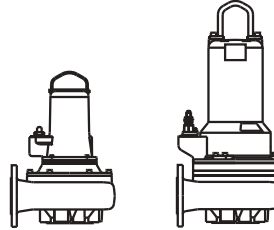

Performance curves

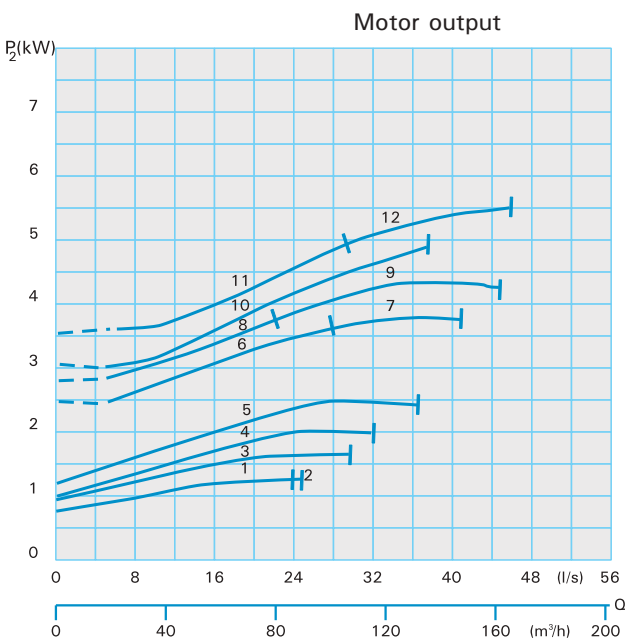
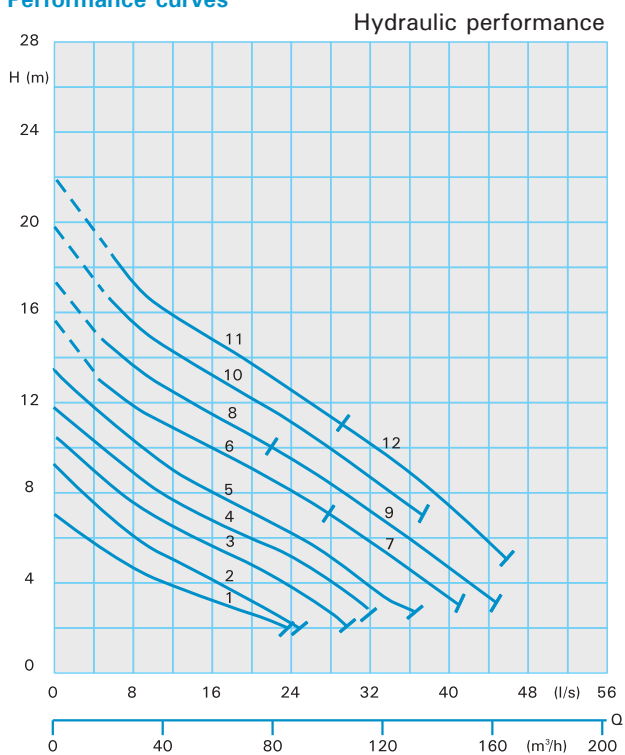

Technical data

Standard- and Explosion-proof model – Wet well installation						
Curve No.	Pump type	Motor input P ₁ (kW)	Motor output P ₂ (kW)	Rated current I _n (A)	Weight standard (kg)	Weight Ex (kg)
1	MX1331-C24(C)(Ex)	1.7	1.3	3.3	67	67
2	MX1336-C24(C)(Ex)	1.7	1.3	3.3	67	67
3	MX1337-D44(C)(Ex)	3.4	2.6	6.2	70	70
4	MX1339-D44(C)(Ex)	3.4	2.6	6.2	70	70
5	MX1341-D44(C)(Ex)	3.4	2.6	6.2	70	70
6	MX1344-T44(C)(Ex)	4.4	3.7	7.5	95	95
7	MX1344-T54(C)(Ex)	5.9	5.0	9.9	108	108
8	MX1346-T44(C)(Ex)	4.4	3.7	7.5	95	95
9	MX1346-T54(C)(Ex)	5.9	5.0	9.9	108	108
10	MX1347-T54(C)(Ex)	5.9	5.0	9.9	108	108
11	MX1350-T54(C)(Ex)	5.9	5.0	9.9	108	108
12	MX1350-T64(C)(Ex)	7.7	6.5	13.1	113	113

Standard- and Explosion-proof model – Dry well installation						
Curve No.	Pump type	Motor input P ₁ (kW)	Motor output P ₂ (kW)	Rated current I _n (A)	Weight standard (kg)	Weight Ex (kg)
1	MX1331-TU34(Ex)	3.4	2.9	5.8	97	97
2	MX1336-TU34(Ex)	3.4	2.9	5.8	97	97
3	MX1337-TU34(Ex)	3.4	2.9	5.8	97	97
4	MX1339-TU34(Ex)	3.4	2.9	5.8	97	97
5	MX1341-TU34(Ex)	3.4	2.9	5.8	97	97
6	MX1344-TU44(Ex)	4.4	3.7	7.5	99	99
7	MX1344-TU54(Ex)	5.9	5.0	9.9	113	113
8	MX1346-TU44(Ex)	4.4	3.7	7.5	99	99
9	MX1346-TU54(Ex)	5.9	5.0	9.9	113	113
10	MX1347-TU54(Ex)	5.9	5.0	9.9	113	113
11	MX1350-TU54(Ex)	5.9	5.0	9.9	113	113
12	MX1350-TU64(Ex)	7.7	6.5	13.1	118	118

DN80 - MX13...-6 pole



Enclosed single channel impeller

80 mm Ø

Spherical clearance

960 rpm

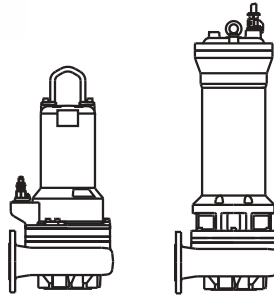

Performance curves

Hydraulic performance

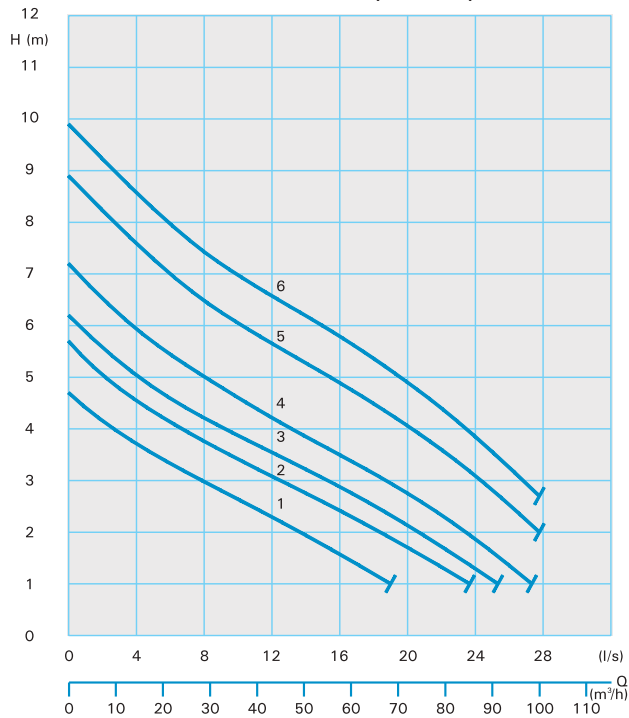

Motor output

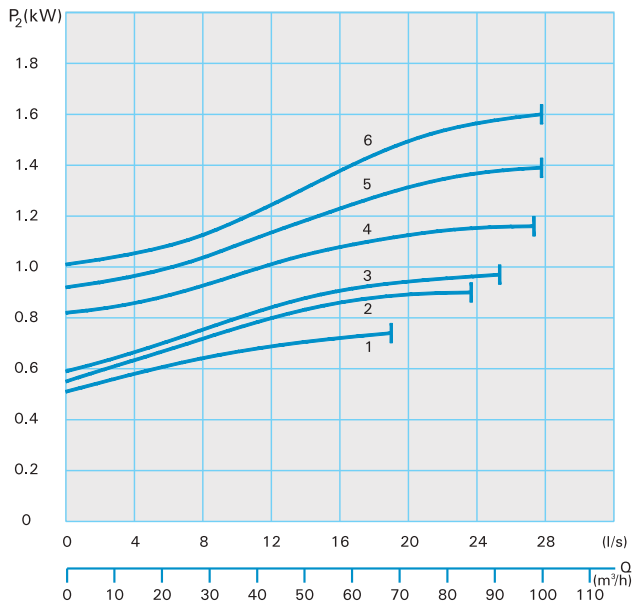

Technical data

Standard- and Explosion-proof model – Wet well installation						
Curve No.	Pump type	Motor input P ₁ (kW)	Motor output P ₂ (kW)	Rated current I _n (A)	Weight standard (kg)	Weight Ex (kg)
1	MX1337-T26(C)(Ex)	3.0	2.3	5.4	92	92
2	MX1338-T26(C)(Ex)	3.0	2.3	5.4	92	92
3	MX1341-T26(C)(Ex)	3.0	2.3	5.4	92	92
4	MX1344-T26(C)(Ex)	3.0	2.3	5.4	107	107
5	MX1347-T26(C)(Ex)	3.0	2.3	5.4	107	107
6	MX1350-T26(C)(Ex)	3.0	2.3	5.4	107	107

Standard- and Explosion-proof model – Dry well installation						
Curve No.	Pump type	Motor input P ₁ (kW)	Motor output P ₂ (kW)	Rated current I _n (A)	Weight standard (kg)	Weight Ex (kg)
1	MX1337-TU26(Ex)	3.0	2.3	5.4	96	96
2	MX1338-TU26(Ex)	3.0	2.3	5.4	96	96
3	MX1341-TU26(Ex)	3.0	2.3	5.4	96	96
4	MX1344-TU26(Ex)	3.0	2.3	5.4	112	112
5	MX1347-TU26(Ex)	3.0	2.3	5.4	112	112
6	MX1350-TU26(Ex)	3.0	2.3	5.4	112	112



Vortex impeller
80 mm Ø
Spherical clearance
2900 rpm

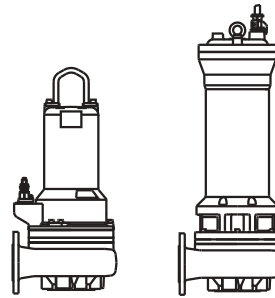

Performance curves

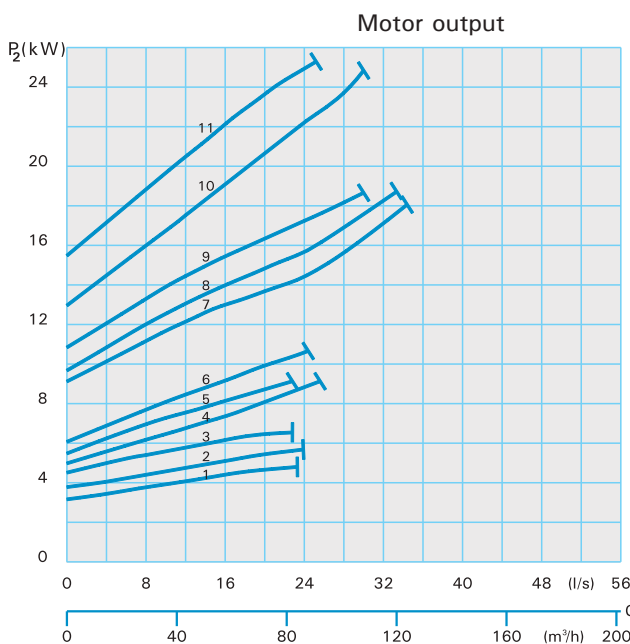
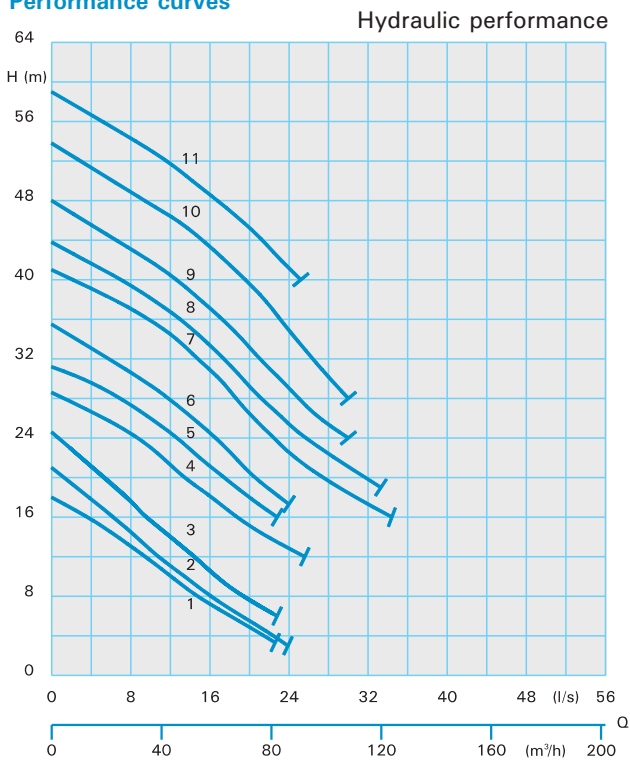

Technical data

Standard- and Explosion-proof model – Wet well installation						
Curve No.	Pump type	Motor input P ₁ (kW)	Motor output P ₂ (kW)	Rated current I _n (A)	Weight standard (kg)	Weight Ex (kg)
1	V1332-T62(C)(Ex)	7.5	6.4	13.0	91	91
2	V1333-T62(C)(Ex)	7.5	6.4	13.0	91	91
3	V1334-T62(C)(Ex)	7.5	6.4	13.0	91	91
4	V1335-T72(C)(Ex)	11.0	9.5	18.8	103	103
5	V1337-T72(C)(Ex)	11.0	9.5	18.8	103	103
6	V1339-T82(C)(Ex)	13.0	11.5	22.2	108	108
7	V1342-P102(C)(Ex)	22.0	19.6	36.9	176	188
8	V1343-P102(C)(Ex)	22.0	19.6	36.9	176	188
9	V1344-P102(C)(Ex)	22.0	19.6	36.9	176	188
10	V1345-P122(C)(Ex)	28.0	25.4	46.3	196	208
11	V1346-P122(C)(Ex)	28.0	25.4	46.3	196	208

Standard- and Explosion-proof model – Dry well installation						
Curve No.	Pump type	Motor input P ₁ (kW)	Motor output P ₂ (kW)	Rated current I _n (A)	Weight standard (kg)	Weight Ex (kg)
1	V1332-TU62(Ex)	7.5	6.4	13.0	94	94
2	V1333-TU62(Ex)	7.5	6.4	13.0	94	94
3	V1334-TU62(Ex)	7.5	6.4	13.0	94	94
4	V1335-TU72(Ex)	11.0	9.5	18.8	108	108
5	V1337-TU72(Ex)	11.0	9.5	18.8	108	108
6	V1339-TU82(Ex)	13.0	11.5	22.2	113	113
7	V1342-PU102(Ex)	22.0	19.6	36.9	188	200
8	V1343-PU102(Ex)	22.0	19.6	36.9	188	200
9	V1344-PU102(Ex)	22.0	19.6	36.9	188	200
10	V1345-PU122(Ex)	28.0	25.4	46.3	208	220
11	V1346-PU122(Ex)	28.0	25.4	46.3	208	220

DN80 - V(X)13...-4 pole



Vortex impeller
80 mm Ø
Spherical clearance
1450 rpm

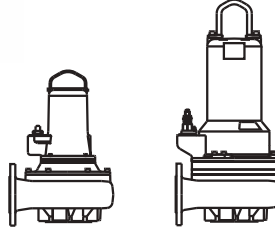

Performance curves

Hydraulic performance

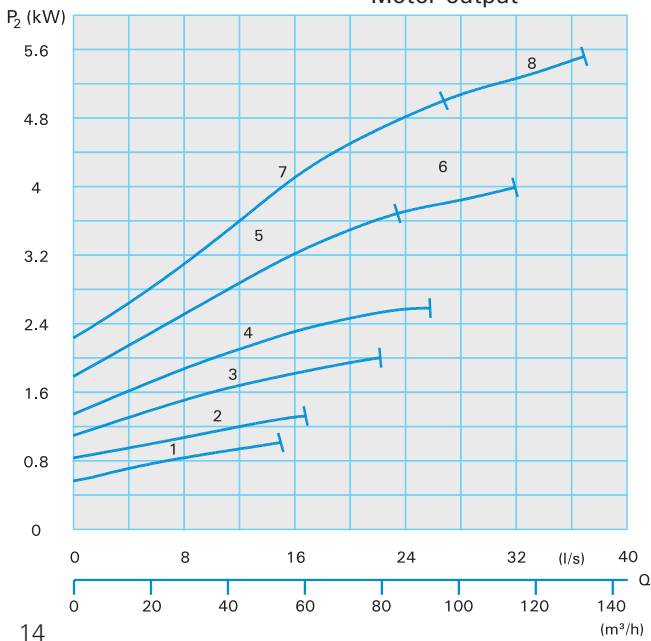
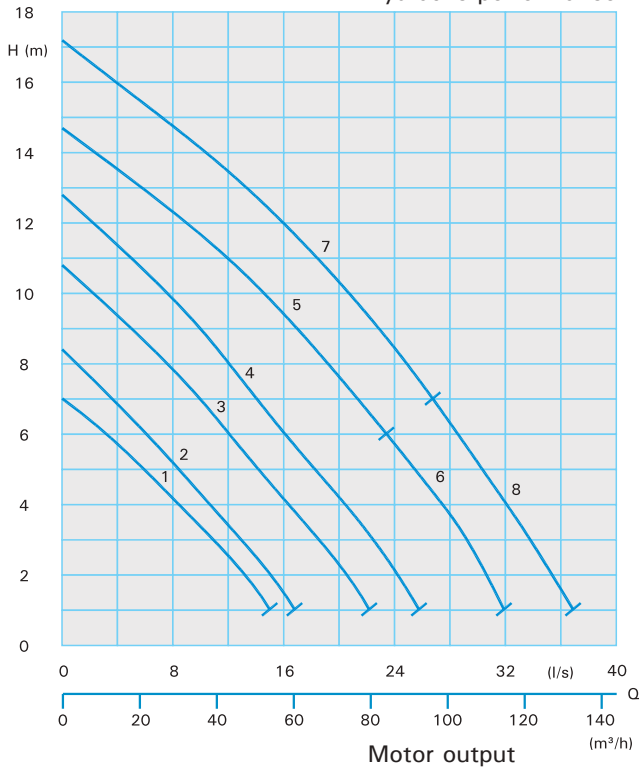

Technical data

Standard- and Explosion-proof model – Wet well installation

Curve No.	Pump type	Motor input P ₁ (kW)	Motor output P ₂ (kW)	Rated current I _N (A)	Weight standard (kg)	Weight Ex (kg)
1	V1334-C24(C)(Ex)	1.7	1.3	3.3	63	64
2	V1336-C24(C)(Ex)	1.7	1.3	3.3	63	64
3	V1344-D44(C)(Ex)	3.4	2.6	6.2	66	67
4	V1346-D44(C)(Ex)	3.4	2.6	6.2	66	67
5	VX1345-T44(C)(Ex)	4.4	3.7	7.5	107	107
6	VX1345-T54(C)(Ex)	5.9	5.0	9.9	117	117
7	VX1346-T54(C)(Ex)	5.9	5.0	9.9	118	118
8	VX1346-T64(C)(Ex)	7.7	6.5	13.1	121	121

Standard- and Explosion-proof model – Dry well installation

Curve No.	Pump type	Motor input P ₁ (kW)	Motor output P ₂ (kW)	Rated current I _N (A)	Weight standard (kg)	Weight Ex (kg)
1	V1334-TU34(Ex)	3.4	2.9	5.8	86	86
2	V1336-TU34(Ex)	3.4	2.9	5.8	86	86
3	V1344-TU34(Ex)	3.4	2.9	5.8	90	90
4	V1346-TU34(Ex)	3.4	2.9	5.8	90	90
5	VX1345-TU44(Ex)	4.4	3.7	7.5	110	110
6	VX1345-TU54(Ex)	5.9	5.0	9.9	121	121
7	VX1346-TU54(Ex)	5.9	5.0	9.9	122	122
8	VX1346-TU64(Ex)	7.7	6.5	13.1	125	125



Enclosed single channel impeller
80 mm Ø
Spherical clearance
2900 rpm

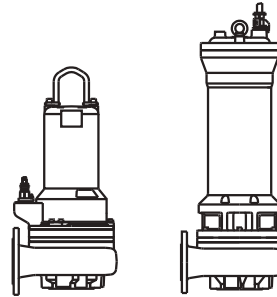

Performance curves

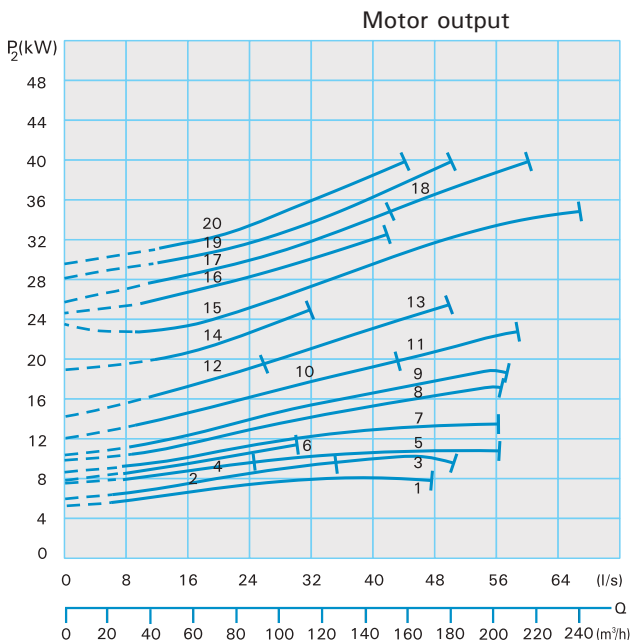
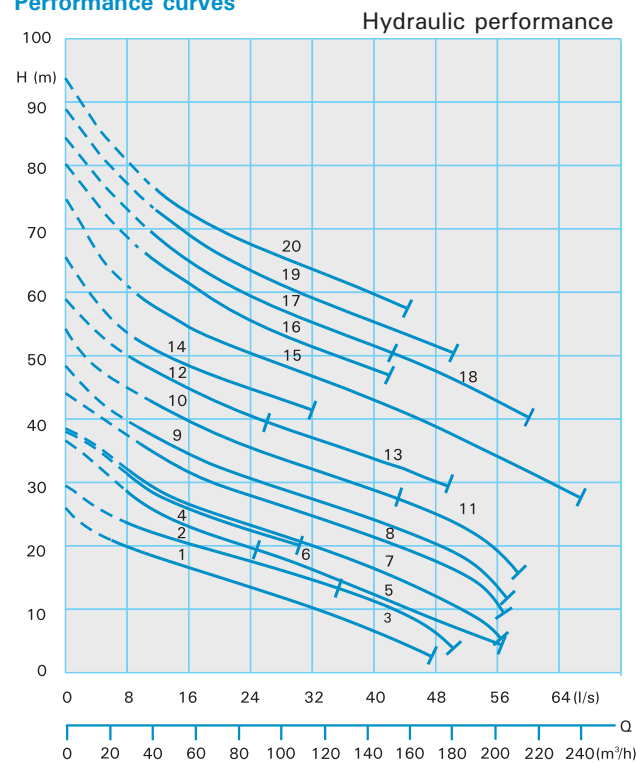

Technical data

Standard- and Explosion-proof model – Wet well installation						
Curve No.	Pump type	Motor input P ₁ (kW)	Motor output P ₂ (kW)	Rated current I _n (A)	Weight standard (kg)	Weight Ex (kg)
1	MX2330-T72(C)(Ex)	11.0	9.5	18.8	105	105
2	MX2331-T72(C)(Ex)	11.0	9.5	18.8	105	105
3	MX2331-T82(C)(Ex)	13.0	11.5	22.2	110	110
4	MX2335-T72(C)(Ex)	11.0	9.5	18.8	105	105
5	MX2335-T82(C)(Ex)	13.0	11.5	22.2	110	110
6	MX2336-T82(C)(Ex)	13.0	11.5	22.2	110	110
7	MX2336-P92(C)(Ex)	22.0	19.6	36.9	180	192
8	MX2337-P102(C)(Ex)	22.0	19.6	36.9	180	192
9	MX2338-P102(C)(Ex)	22.0	19.6	36.9	180	192
10	MX2339-P102(C)(Ex)	22.0	19.6	36.9	180	192
11	MX2339-P122(C)(Ex)	28.0	25.4	46.3	200	212
12	MX2341-P102(C)(Ex)	22.0	19.6	36.9	180	192
13	MX2341-P122(C)(Ex)	28.0	25.4	46.3	200	212
14	MX2344-P122(C)(Ex)	28.0	25.4	46.3	203	215
15	MX2346-F152(C)(Ex)	38.0	35.0	59.4	330	330
16	MX2347-F152(C)(Ex)	38.0	35.0	59.4	330	330
17	MX2348-F152(C)(Ex)	38.0	35.0	59.4	331	331
18	MX2348-F162(C)(Ex)	43.0	40.0	67.5	348	348
19	MX2349-F162(C)(Ex)	43.0	40.0	67.5	349	349
20	MX2350-F162(C)(Ex)	43.0	40.0	67.5	350	350

Standard- and Explosion-proof model – Dry well installation						
Curve No.	Pump type	Motor input P ₁ (kW)	Motor output P ₂ (kW)	Rated current I _n (A)	Weight standard (kg)	Weight Ex (kg)
1	MX2330-TU72(Ex)	11.0	9.5	18.8	110	110
2	MX2331-TU72(Ex)	11.0	9.5	18.8	110	110
3	MX2331-TU82(Ex)	13.0	11.5	22.2	115	115
4	MX2335-TU72(Ex)	11.0	9.5	18.8	110	110
5	MX2335-TU82(Ex)	13.0	11.5	22.2	115	115
6	MX2336-TU82(Ex)	13.0	11.5	22.2	115	115
7	MX2336-PU92(Ex)	22.0	19.6	36.9	192	204
8	MX2337-PU102(Ex)	22.0	19.6	36.9	192	204
9	MX2338-PU102(Ex)	22.0	19.6	36.9	192	204
10	MX2339-PU102(Ex)	22.0	19.6	36.9	192	204
11	MX2339-PU122(Ex)	28.0	25.4	46.3	212	224
12	MX2341-PU102(Ex)	22.0	19.6	36.9	192	204
13	MX2341-PU122(Ex)	28.0	25.4	46.3	212	224
14	MX2344-PU122(Ex)	28.0	25.4	46.3	215	227
15	MX2346-FU152(Ex)	38.0	35.0	59.4	361	361
16	MX2347-FU152(Ex)	38.0	35.0	59.4	361	361
17	MX2348-FU152(Ex)	38.0	35.0	59.4	362	362
18	MX2348-FU162(Ex)	43.0	40.0	67.5	381	381
19	MX2349-FU162(Ex)	43.0	40.0	67.5	382	382
20	MX2350-FU162(Ex)	43.0	40.0	67.5	383	383

DN100 - MX23...4-pole



Enclosed single channel impeller

80 mm Ø

Spherical clearance

1450 rpm

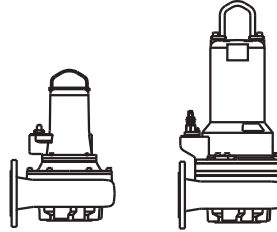

Performance curves

Hydraulic performance

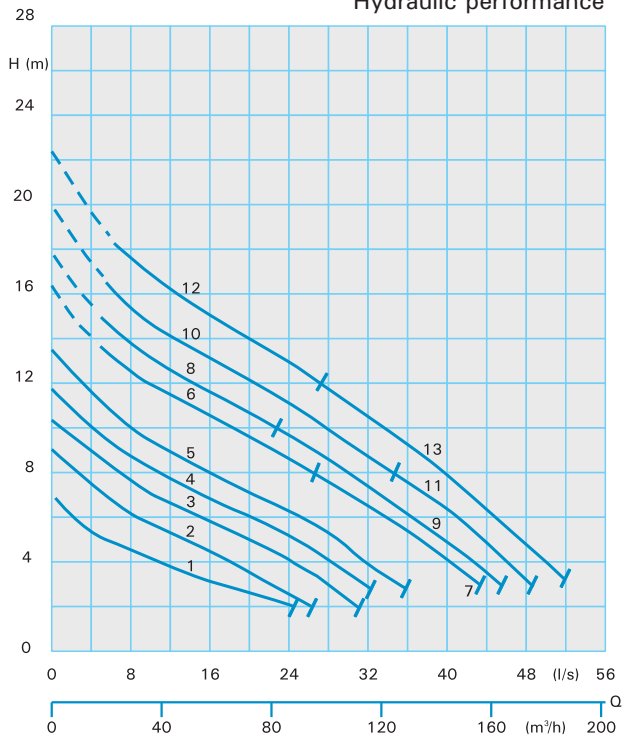

Motor output

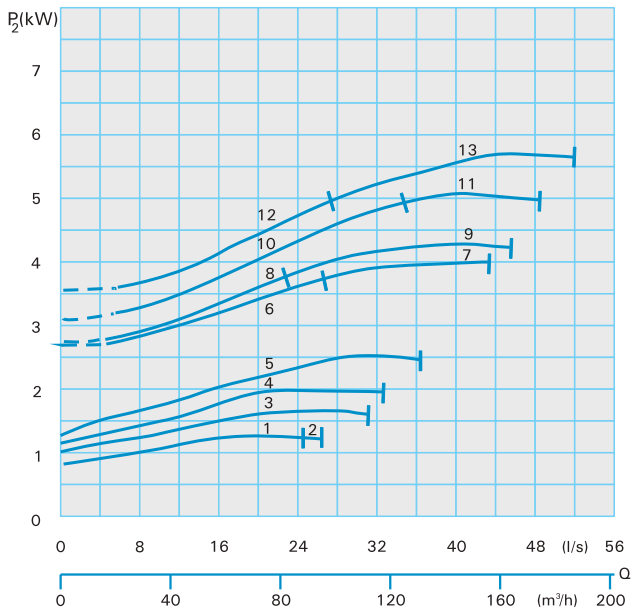

Technical data

Standard- and Explosion-proof model – Wet well installation						
Curve No.	Pump type	Motor input P ₁ (kW)	Motor output P ₂ (kW)	Rated current I _n (A)	Weight standard (kg)	Weight Ex (kg)
1	MX2331-C24(C)(Ex)	1.7	1.3	3.3	68	68
2	MX2336-C24(C)(Ex)	1.7	1.3	3.3	68	68
3	MX2337-D44(C)(Ex)	3.4	2.6	6.2	71	71
4	MX2339-D44(C)(Ex)	3.4	2.6	6.2	71	71
5	MX2341-D44(C)(Ex)	3.4	2.6	6.2	71	71
6	MX2344-T44(C)(Ex)	4.4	3.7	7.5	96	96
7	MX2344-T54(C)(Ex)	5.9	5.0	9.9	109	109
8	MX2346-T44(C)(Ex)	4.4	3.7	7.5	96	96
9	MX2346-T54(C)(Ex)	5.9	5.0	9.9	109	109
10	MX2347-T54(C)(Ex)	5.9	5.0	9.9	109	109
11	MX2347-T64(C)(Ex)	7.7	6.5	13.1	114	114
12	MX2350-T54(C)(Ex)	5.9	5.0	9.9	109	109
13	MX2350-T64(C)(Ex)	7.7	6.5	13.1	114	114

Standard- and Explosion-proof model – Dry well installation						
Curve No.	Pump type	Motor input P ₁ (kW)	Motor output P ₂ (kW)	Rated current I _n (A)	Weight standard (kg)	Weight Ex (kg)
1	MX2331-TU34(Ex)	3.4	2.9	5.8	98	98
2	MX2336-TU34(Ex)	3.4	2.9	5.8	98	98
3	MX2337-TU34(Ex)	3.4	2.9	5.8	98	98
4	MX2339-TU34(Ex)	3.4	2.9	5.8	98	98
5	MX2341-TU34(Ex)	3.4	2.9	5.8	98	98
6	MX2344-TU44(Ex)	4.4	3.7	7.5	100	100
7	MX2344-TU54(Ex)	5.9	5.0	9.9	114	114
8	MX2346-TU44(Ex)	4.4	3.7	7.5	100	100
9	MX2346-TU54(Ex)	5.9	5.0	9.9	114	114
10	MX2347-TU54(Ex)	5.9	5.0	9.9	114	114
11	MX2347-TU64(Ex)	7.7	6.5	13.1	119	119
12	MX2350-TU54(Ex)	5.9	5.0	9.9	114	114
13	MX2350-TU64(Ex)	7.7	6.5	13.1	119	119



Vortex impeller
80 mm Ø
Spherical clearance
2900 rpm

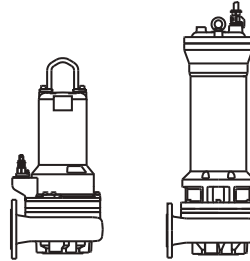

Performance curves

Hydraulic performance

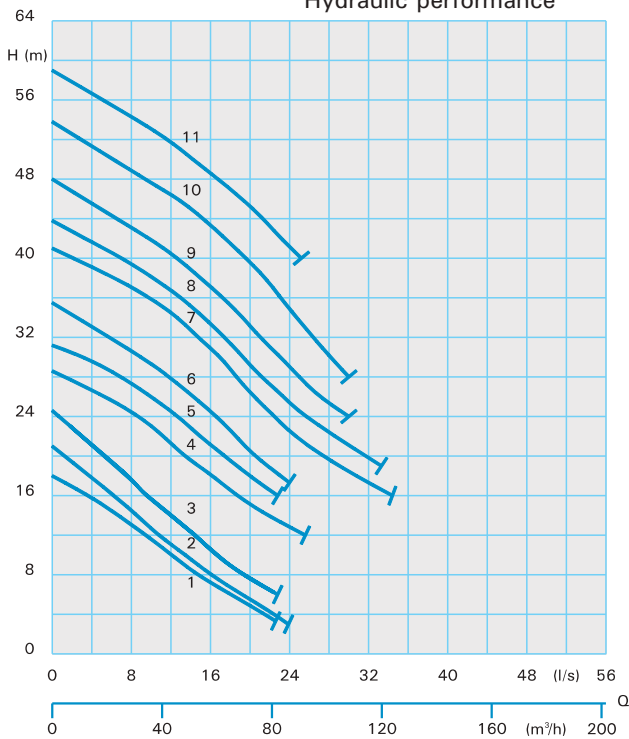

Motor output

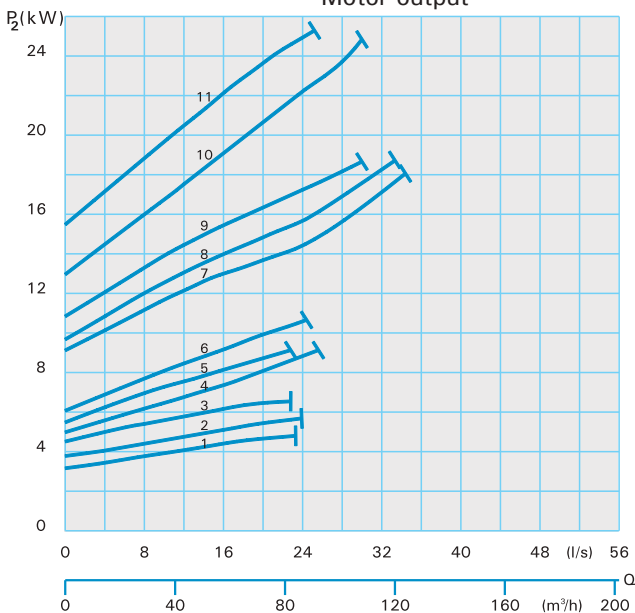

Technical data

Standard- and Explosion-proof model – Wet well installation

Curve No.	Pump type	Motor input P ₁ (kW)	Motor output P ₂ (kW)	Rated current I _n (A)	Weight standard (kg)	Weight Ex (kg)
1	V2332-T62(C)(Ex)	7.5	6.4	13.0	93	93
2	V2333-T62(C)(Ex)	7.5	6.4	13.0	93	93
3	V2334-T62(C)(Ex)	7.5	6.4	13.0	93	93
4	V2335-T72(C)(Ex)	11.0	9.5	18.8	105	105
5	V2337-T72(C)(Ex)	11.0	9.5	18.8	105	105
6	V2339-T82(C)(Ex)	13.0	11.5	22.2	110	110
7	V2342-P102(C)(Ex)	22.0	19.6	36.9	178	190
8	V2343-P102(C)(Ex)	22.0	19.6	36.9	178	190
9	V2344-P102(C)(Ex)	22.0	19.6	36.9	178	190
10	V2345-P122(C)(Ex)	28.0	25.4	46.3	198	210
11	V2346-P122(C)(Ex)	28.0	25.4	46.3	198	210

Standard- and Explosion-proof model – Dry well installation

Curve No.	Pump type	Motor input P ₁ (kW)	Motor output P ₂ (kW)	Rated current I _n (A)	Weight standard (kg)	Weight Ex (kg)
1	V2332-TU62(Ex)	7.5	6.4	13.0	96	96
2	V2333-TU62(Ex)	7.5	6.4	13.0	96	96
3	V2334-TU62(Ex)	7.5	6.4	13.0	96	96
4	V2335-TU72(Ex)	11.0	9.5	18.8	110	110
5	V2337-TU72(Ex)	11.0	9.5	18.8	110	110
6	V2339-TU82(Ex)	13.0	11.5	22.2	115	115
7	V2342-PU102(Ex)	22.0	19.6	36.9	190	202
8	V2343-PU102(Ex)	22.0	19.6	36.9	190	202
9	V2344-PU102(Ex)	22.0	19.6	36.9	190	202
10	V2345-PU122(Ex)	28.0	25.4	46.3	210	222
11	V2346-PU122(Ex)	28.0	25.4	46.3	210	222

DN100 - V(X)23...-4 pole



Vortex impeller
80 mm Ø
Spherical clearance
1450 rpm

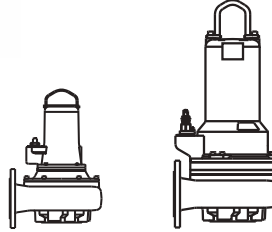

Performance curves

Hydraulic performance

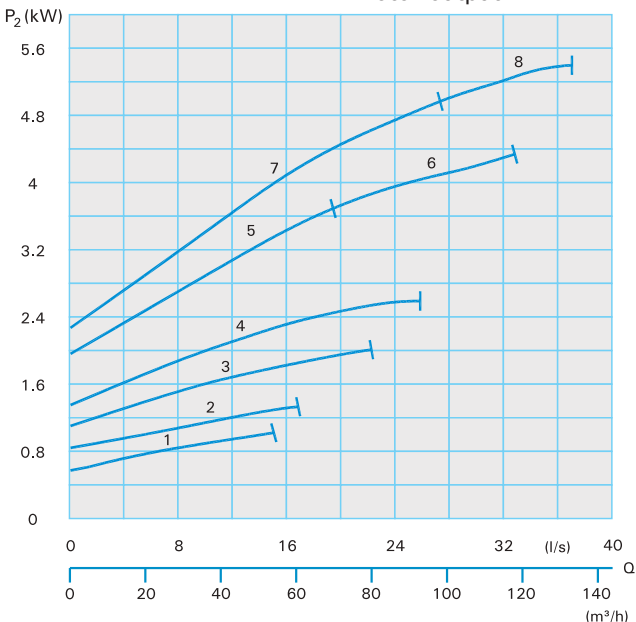
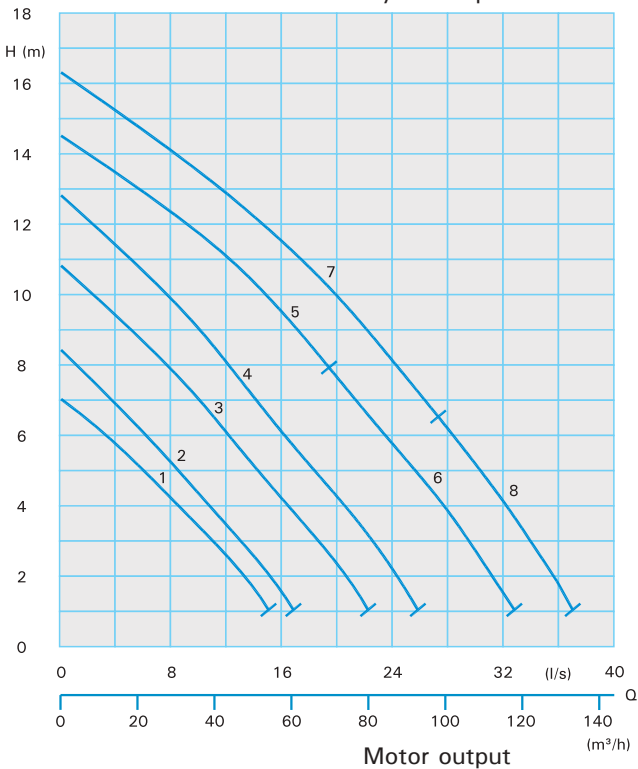

Technical data

Standard- and Explosion-proof model – Wet well installation

Curve No.	Pump type	Motor input P ₁ (kW)	Motor output P ₂ (kW)	Rated current I _N (A)	Weight standard (kg)	Weight Ex (kg)
1	V2334-C24(C)(Ex)	1.7	1.3	3.3	65	66
2	V2336-C24(C)(Ex)	1.7	1.3	3.3	65	66
3	V2344-D44(C)(Ex)	3.4	2.6	6.2	68	69
4	V2346-D44(C)(Ex)	3.4	2.6	6.2	68	69
5	VX2345-T44(C)(Ex)	4.4	3.7	7.5	109	109
6	VX2345-T54(C)(Ex)	5.9	5.0	9.9	119	119
7	VX2346-T54(C)(Ex)	5.9	5.0	9.9	120	120
8	VX2346-T64(C)(Ex)	7.7	6.5	13.1	123	123

Standard- and Explosion-proof model – Dry well installation

Curve No.	Pump type	Motor input P ₁ (kW)	Motor output P ₂ (kW)	Rated current I _N (A)	Weight standard (kg)	Weight Ex (kg)
1	V2334-TU34(Ex)	3.4	2.9	5.8	87	87
2	V2336-TU34(Ex)	3.4	2.9	5.8	87	87
3	V2344-TU34(Ex)	3.4	2.9	5.8	91	91
4	V2346-TU34(Ex)	3.4	2.9	5.8	91	91
5	VX2345-TU44(Ex)	4.4	3.7	7.5	112	112
6	VX2345-TU54(Ex)	5.9	5.0	9.9	123	123
7	VX2346-TU54(Ex)	5.9	5.0	9.9	124	124
8	VX2346-TU64(Ex)	7.7	6.5	13.1	127	127



Enclosed single channel impeller

100 mm Ø

Spherical clearance

1450 rpm

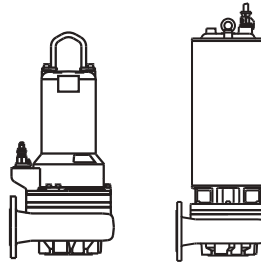

Performance curves

Hydraulic performance

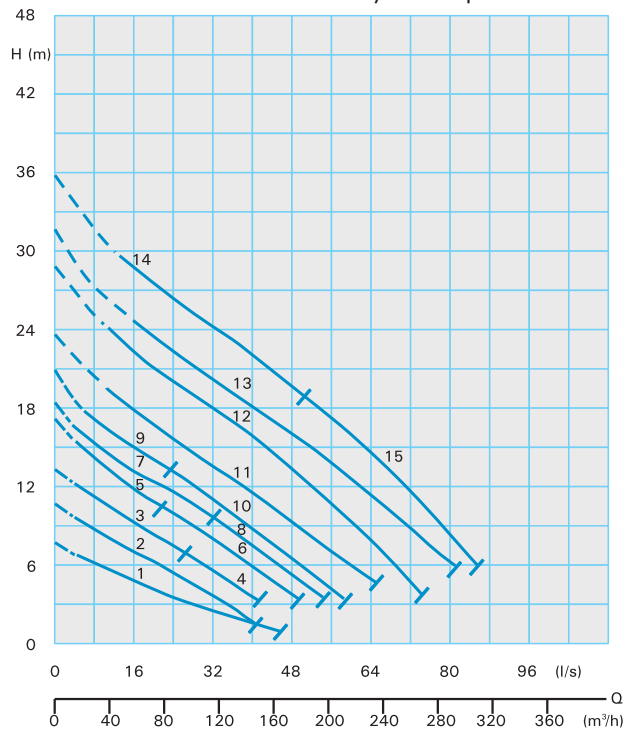

Motor output

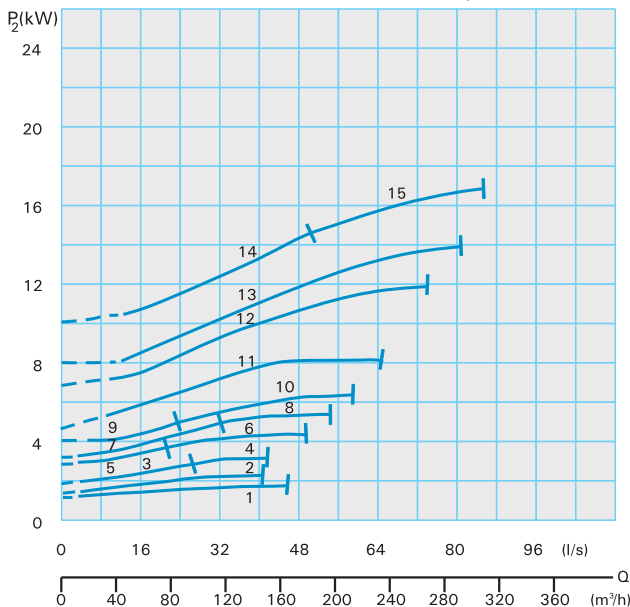

Technical data

Standard- and Explosion-proof model – Wet well installation

Curve No.	Pump type	Motor input P ₁ (kW)	Motor output P ₂ (kW)	Rated current I _n (A)	Weight standard (kg)	Weight Ex (kg)
1	M2432-T34(C)(Ex)	3.4	2.9	5.8	102	102
2	MX2436-T34(C)(Ex)	3.4	2.9	5.8	104	104
3	MX2438-T34(C)(Ex)	3.4	2.9	5.8	104	104
4	MX2438-T44(C)(Ex)	4.4	3.7	7.5	108	108
5	MX2444-T44(C)(Ex)	4.4	3.7	7.5	109	109
6	MX2444-T54(C)(Ex)	5.9	5.0	9.9	111	111
7	MX2446-T54(C)(Ex)	5.9	5.0	9.9	111	111
8	MX2446-T64(C)(Ex)	7.7	6.5	13.1	114	114
9	MX2448-T54(C)(Ex)	5.9	5.0	9.9	111	111
10	MX2448-T64(C)(Ex)	7.7	6.5	13.1	114	114
11	MX2452-P74(C)(Ex)	10.0	8.5	16.8	184	196
12	MX2456-P84(C)(Ex)	17.0	14.6	28.8	211	223
13	MX2460-P94(C)(Ex)	17.0	14.6	28.8	212	224
14	MX2462-P94(C)(Ex)	17.0	14.6	28.8	213	225
15	MX2462-P104(C)(Ex)	22.0	19.3	39.1	231	243

Standard- and Explosion-proof model – Dry well installation

Curve No.	Pump type	Motor input P ₁ (kW)	Motor output P ₂ (kW)	Rated current I _n (A)	Weight standard (kg)	Weight Ex (kg)
1	M2432-TU34(Ex)	3.4	2.9	5.8	105	105
2	MX2436-TU34(Ex)	3.4	2.9	5.8	107	107
3	MX2438-TU34(Ex)	3.4	2.9	5.8	107	107
4	MX2438-TU44(Ex)	4.4	3.7	7.5	111	111
5	MX2444-TU44(Ex)	4.4	3.7	7.5	112	112
6	MX2444-TU54(Ex)	5.9	5.0	9.9	115	115
7	MX2446-TU54(Ex)	5.9	5.0	9.9	115	115
8	MX2446-TU64(Ex)	7.7	6.5	13.1	118	118
9	MX2448-TU54(Ex)	5.9	5.0	9.9	115	115
10	MX2448-TU64(Ex)	7.7	6.5	13.1	118	118
11	MX2452-PU74(Ex)	10.0	8.5	16.8	191	203
12	MX2456-PU84(Ex)	17.0	14.6	28.8	216	231
13	MX2460-PU94(Ex)	17.0	14.6	28.8	220	232
14	MX2462-PU94(Ex)	17.0	14.6	28.8	221	233
15	MX2462-PU104(Ex)	22.0	19.3	39.1	241	253

DN100 - MX24...-6 pole



Enclosed single channel impeller
100 mm Ø
Spherical clearance
960 rpm

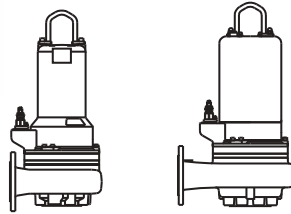

Performance curves

Hydraulic performance

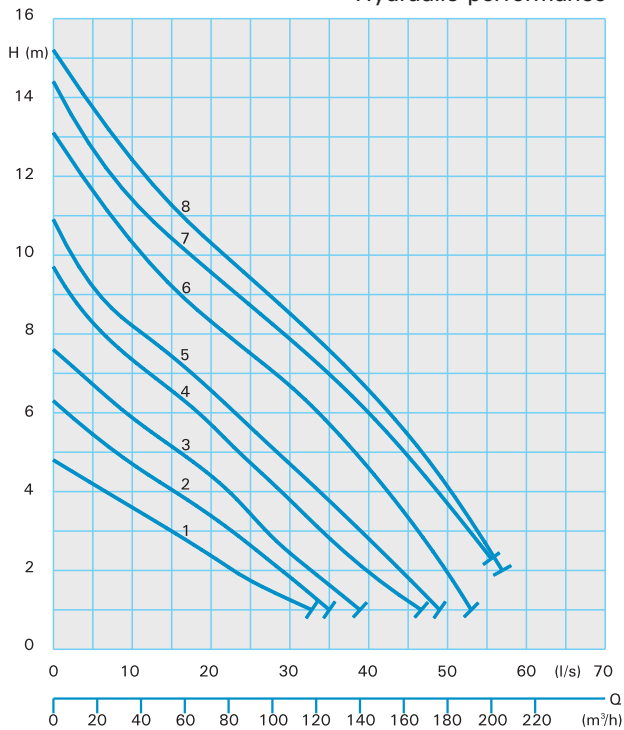

Motor output

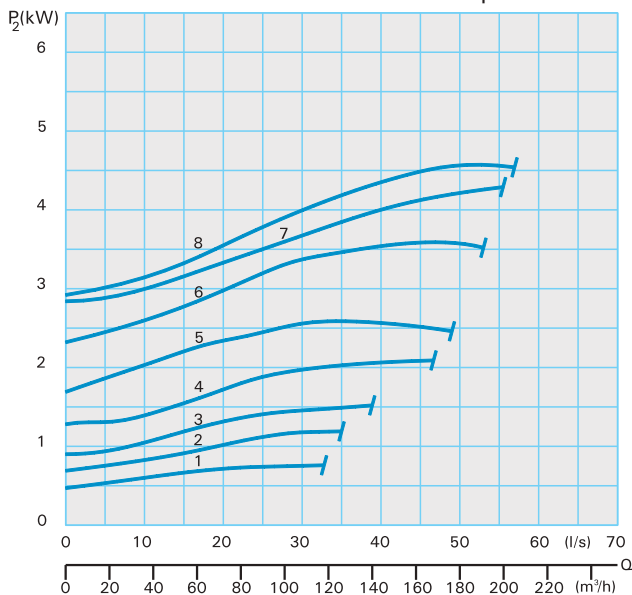

Technical data

Standard- and Explosion-proof model – Wet well installation

Curve No.	Pump type	Motor input P_1 (kW)	Motor output P_2 (kW)	Rated current I_n (A)	Weight standard (kg)	Weight Ex (kg)
1	MX2436-T36(C)(Ex)	3.0	2.3	5.4	104	104
2	MX2438-T36(C)(Ex)	3.0	2.3	5.4	104	104
3	MX2446-T36(C)(Ex)	3.0	2.3	5.4	109	109
4	MX2448-T36(C)(Ex)	3.0	2.3	5.4	109	109
5	MX2452-T46(C)(Ex)	4.0	3.1	7.3	148	148
6	MX2456-T56(C)(Ex)	5.0	4.0	9.6	154	154
7	MX2460-T66(C)(Ex)	6.0	4.9	11.5	155	155
8	MX2462-T66(C)(Ex)	6.0	4.9	11.5	156	156

Standard- and Explosion-proof model – Dry well installation

Curve No.	Pump type	Motor input P_1 (kW)	Motor output P_2 (kW)	Rated current I_n (A)	Weight standard (kg)	Weight Ex (kg)
1	MX2436-TU36(Ex)	3.0	2.3	5.4	107	107
2	MX2438-TU36(Ex)	3.0	2.3	5.4	107	107
3	MX2446-TU36(Ex)	3.0	2.3	5.4	112	112
4	MX2448-TU36(Ex)	3.0	2.3	5.4	112	112
5	MX2452-TU46(Ex)	4.0	3.1	7.3	154	154
6	MX2456-TU56(Ex)	5.0	4.0	9.6	160	160
7	MX2460-TU66(Ex)	6.0	4.9	11.5	161	161
8	MX2462-TU66(Ex)	6.0	4.9	11.5	162	162



Vortex impeller
100 mm Ø
Spherical clearance
1450 rpm

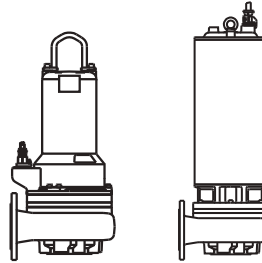

Performance curves

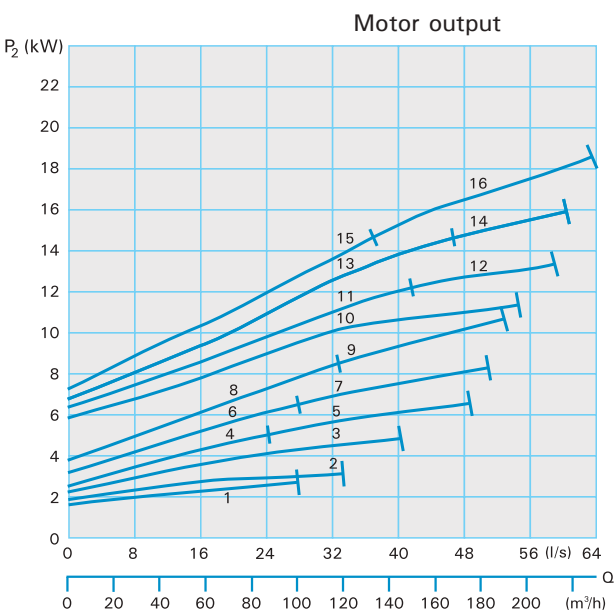
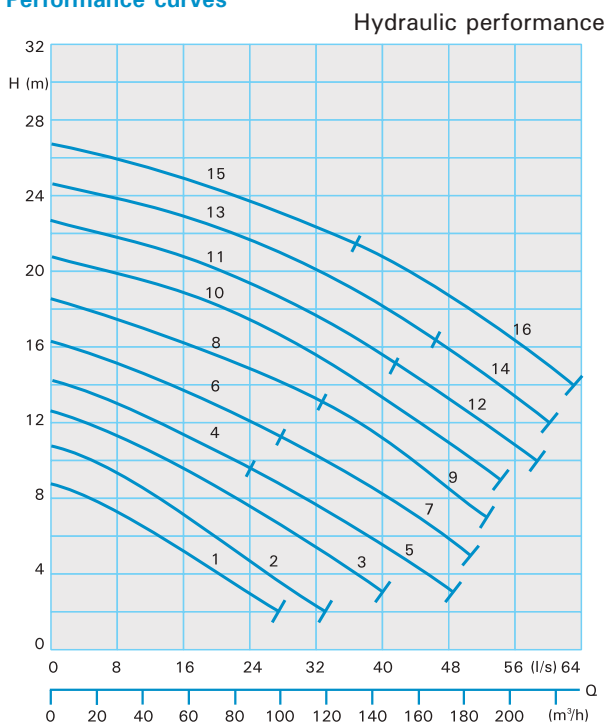

Technical data

Standard- and Explosion-proof model – Wet well installation						
Curve No.	Pump type	Motor input P ₁ (kW)	Motor output P ₂ (kW)	Rated current I _n (A)	Weight standard (kg)	Weight Ex (kg)
1	VX2436-D54(C)(Ex)	4.1	3.2	7.3	78	78
2	VX2439-D54(C)(Ex)	4.1	3.2	7.3	78	78
3	VX2440-T54(C)(Ex)	5.9	5.0	9.9	123	123
4	VX2442-T54(C)(Ex)	5.9	5.0	9.9	123	123
5	VX2442-T64(C)(Ex)	7.7	6.5	13.1	126	126
6	VX2444-T64(C)(Ex)	7.7	6.5	13.1	126	126
7	VX2444-P74(C)(Ex)	10.0	8.5	16.8	152	152
8	VX2446-P74(C)(Ex)	10.0	8.5	16.8	152	152
9	VX2446-P84(C)(Ex)	14.0	12.2	23.0	177	177
10	VX2452-P84(C)(Ex)	14.0	12.2	23.0	205	205
11	VX2454-P84(C)(Ex)	14.0	12.2	23.0	205	205
12	VX2454-P94(C)(Ex)	17.0	14.6	28.8	205	205
13	VX2456-P94(C)(Ex)	17.0	14.6	28.8	205	205
14	VX2456-P104(C)(Ex)	22.0	19.3	39.1	227	227
15	VX2458-P94(C)(Ex)	17.0	14.6	28.8	205	205
16	VX2458-P104(C)(Ex)	22.0	19.3	39.1	227	227

Standard- and Explosion-proof model – Dry well installation						
Curve No.	Pump type	Motor input P ₁ (kW)	Motor output P ₂ (kW)	Rated current I _n (A)	Weight standard (kg)	Weight Ex (kg)
1	VX2436-TU44(Ex)	4.4	3.7	7.5	113	113
2	VX2439-TU44(Ex)	4.4	3.7	7.5	113	113
3	VX2440-TU54(Ex)	5.9	5.0	9.9	127	127
4	VX2442-TU54(Ex)	5.9	5.0	9.9	127	127
5	VX2442-TU64(Ex)	7.7	6.5	13.1	130	130
6	VX2444-TU64(Ex)	7.7	6.5	13.1	130	130
7	VX2444-PU74(Ex)	10.0	8.5	16.8	160	160
8	VX2446-PU74(Ex)	10.0	8.5	16.8	160	160
9	VX2446-PU84(Ex)	14.0	12.2	23.0	187	187
10	VX2452-PU84(Ex)	14.0	12.2	23.0	215	215
11	VX2454-PU84(Ex)	14.0	12.2	23.0	215	215
12	VX2454-PU94(Ex)	17.0	14.6	28.8	215	215
13	VX2456-PU94(Ex)	17.0	14.6	28.8	215	215
14	VX2456-PU104(Ex)	22.0	19.3	39.1	240	240
15	VX2458-PU94(Ex)	17.0	14.6	28.8	215	215
16	VX2458-PU104(Ex)	22.0	19.3	39.1	240	240

DN150 - MX34...-4 pole



Enclosed single channel impeller

100 mm Ø

Spherical clearance

1450 rpm

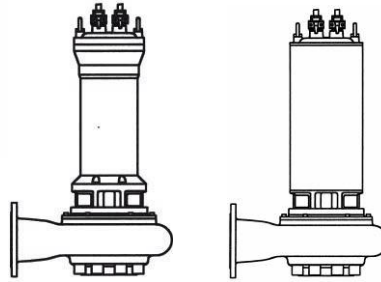

Performance curves

Hydraulic performance

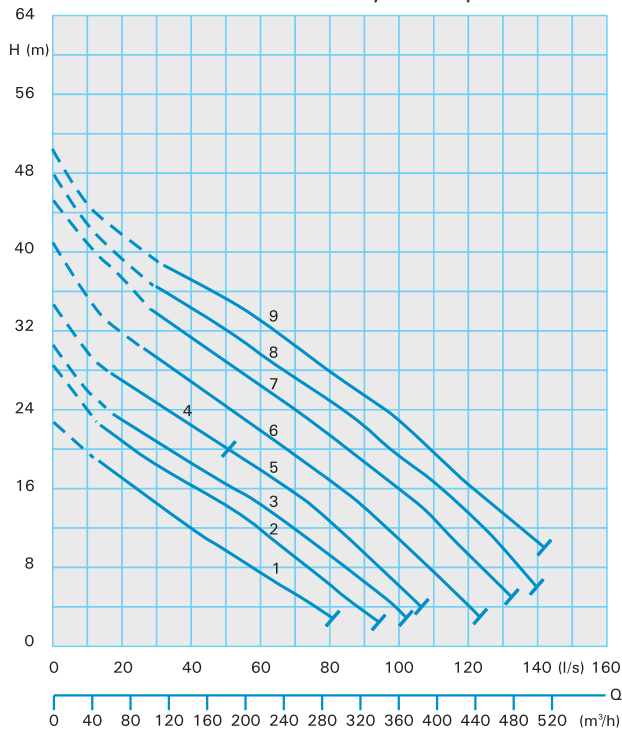

Motor output

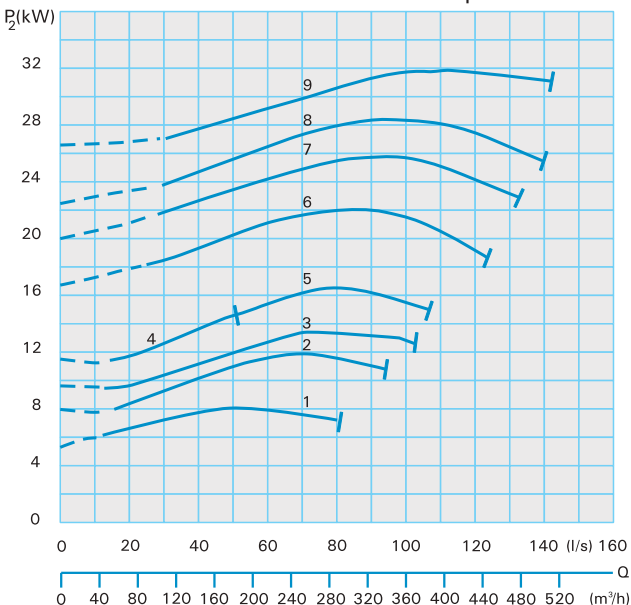

Technical data

Standard- and Explosion-proof model – Wet well installation

Curve No.	Pump type	Motor input P ₁ (kW)	Motor output P ₂ (kW)	Rated current I _n (A)	Weight standard (kg)	Weight Ex (kg)
1	MX3452-P74(C)(Ex)	10.0	8.5	16.8	189	201
2	MX3456-P84(C)(Ex)	17.0	14.6	28.8	216	228
3	MX3460-P94(C)(Ex)	17.0	14.6	28.8	217	229
4	MX3462-P94(C)(Ex)	17.0	14.6	28.8	218	230
5	MX3462-P104(C)(Ex)	22.0	19.3	39.1	236	248
6	MX3468-F114(C)(Ex)	25.0	22.0	44.0	388	388
7	MX3470-F124(C)(Ex)	29.0	25.6	51.4	410	410
8	MX3472-F134(C)(Ex)	33.0	29.2	59.0	420	420
9	MX3474-F144(C)(Ex)	37.0	33.0	67.1	430	430

Standard- and Explosion-proof model – Dry well installation

Curve No.	Pump type	Motor input P ₁ (kW)	Motor output P ₂ (kW)	Rated current I _n (A)	Weight standard (kg)	Weight Ex (kg)
1	MX3452-PU74(Ex)	10.0	8.5	16.8	196	208
2	MX3456-PU84(Ex)	17.0	14.6	28.8	224	236
3	MX3460-PU94(Ex)	17.0	14.6	28.8	225	237
4	MX3462-PU94(Ex)	17.0	14.6	28.8	226	238
5	MX3462-PU104(Ex)	22.0	19.3	39.1	246	258
6	MX3468-FU114(Ex)	25.0	22.0	44.0	451	451
7	MX3470-FU124(Ex)	29.0	25.6	51.4	488	488
8	MX3472-FU134(Ex)	33.0	29.2	59.0	498	498
9	MX3474-FU144(Ex)	37.0	33.0	67.1	508	508



Enclosed single channel impeller
100 mm Ø
Spherical clearance
960 rpm

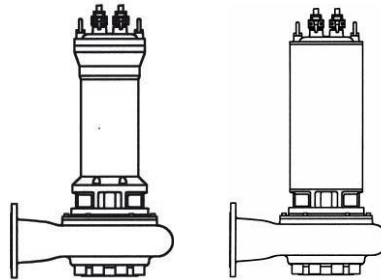

Performance curves

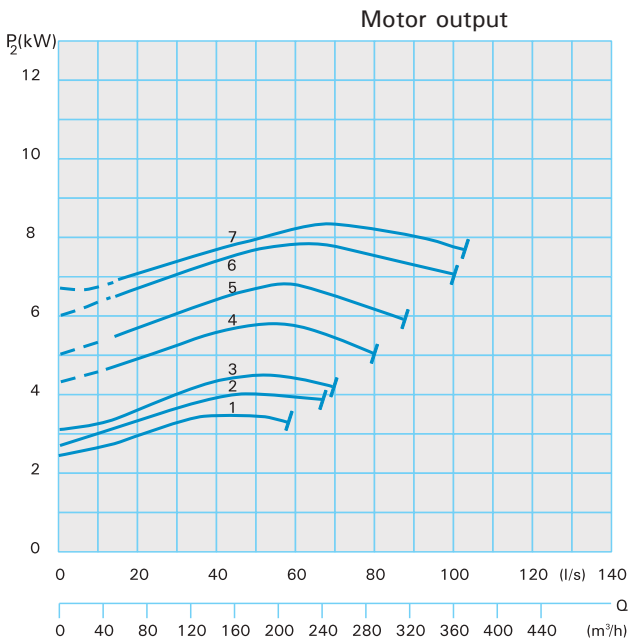
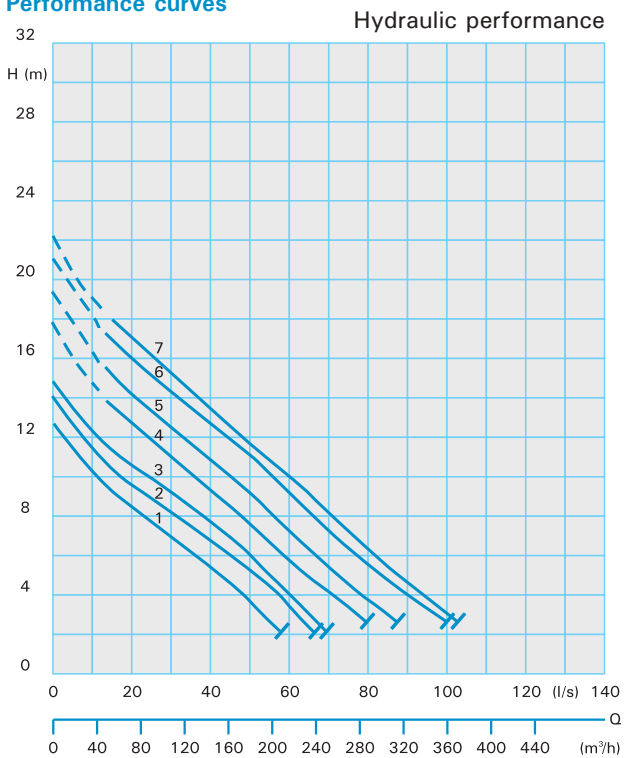

Technical data

Standard- and Explosion-proof model – Wet well installation						
Curve No.	Pump type	Motor input P ₁ (kW)	Motor output P ₂ (kW)	Rated current I _N (A)	Weight standard (kg)	Weight Ex (kg)
1	MX3456-T56(C)(Ex)	5.0	4.0	9.6	158	158
2	MX3460-T66(C)(Ex)	6.0	4.9	11.5	159	159
3	MX3462-T66(C)(Ex)	6.0	4.9	11.5	160	160
4	MX3468-P76(C)(Ex)	9.0	7.3	16.3	260	272
5	MX3470-P76(C)(Ex)	9.0	7.3	16.3	260	272
6	MX3472-P86(C)(Ex)	12.0	10.0	22.4	285	297
7	MX3474-P86(C)(Ex)	12.0	10.0	22.4	285	297

Standard- and Explosion-proof model – Dry well installation						
Curve No.	Pump type	Motor input P ₁ (kW)	Motor output P ₂ (kW)	Rated current I _N (A)	Weight standard (kg)	Weight Ex (kg)
1	MX3456-TU56(Ex)	5.0	4.0	9.6	164	164
2	MX3460-TU66(Ex)	6.0	4.9	11.5	165	165
3	MX3462-TU66(Ex)	6.0	4.9	11.5	166	166
4	MX3468-PU76(Ex)	9.0	7.3	16.3	267	279
5	MX3470-PU76(Ex)	9.0	7.3	16.3	267	279
6	MX3472-PU86(Ex)	12.0	10.0	22.4	292	304
7	MX3474-PU86(Ex)	12.0	10.0	22.4	292	304

DN150 - K33...-4 pole



Enclosed two channel impeller
80 mm Ø
Spherical clearance
1450 rpm

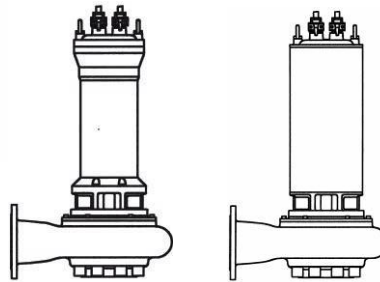

Performance curves

Hydraulic performance

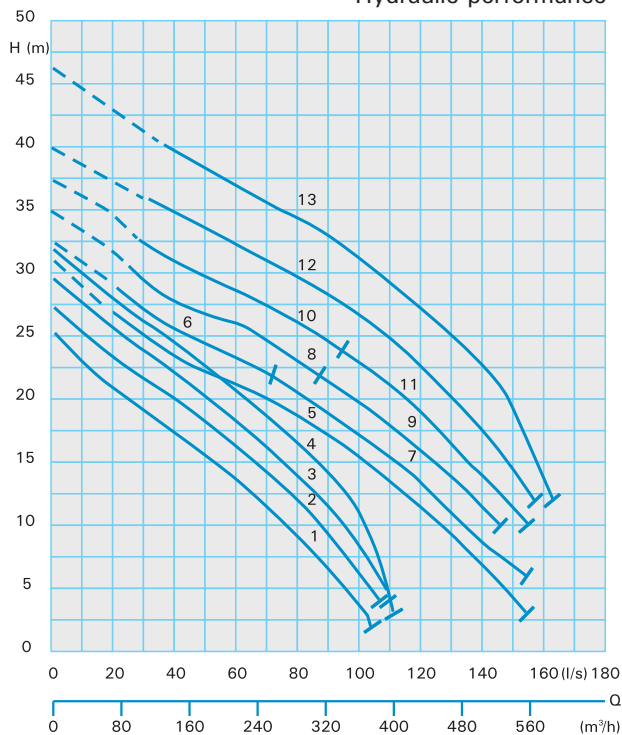

Motor output

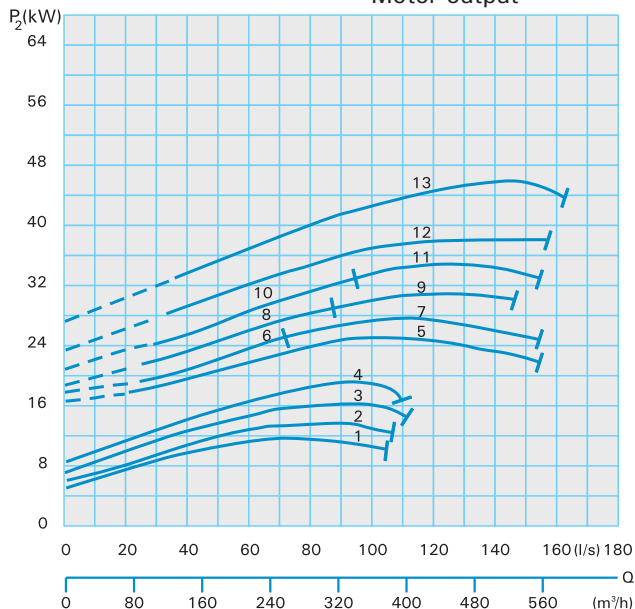

Technical data

Standard- and Explosion-proof model – Wet well installation

Curve No.	Pump type	Motor input P ₁ (kW)	Motor output P ₂ (kW)	Rated current I _N (A)	Weight standard (kg)	Weight Ex (kg)
1	K3352-P94(C)(Ex)	17.0	14.6	28.8	216	228
2	K3354-P94(C)(Ex)	17.0	14.6	28.8	216	228
3	K3356-P104(C)(Ex)	22.0	19.3	39.1	234	246
4	K3358-P104(C)(Ex)	22.0	19.3	39.1	234	246
5	K3360-F124(C)(Ex)	29.0	25.6	51.4	418	418
6	K3362-F124(C)(Ex)	29.0	25.6	51.4	418	418
7	K3362-F134(C)(Ex)	33.0	29.2	59.0	428	428
8	K3364-F134(C)(Ex)	33.0	29.2	59.0	428	428
9	K3364-F144(C)(Ex)	37.0	33.0	67.1	449	449
10	K3366-F144(C)(Ex)	37.0	33.0	67.1	449	449
11	K3366-G154(C)(Ex)	41.0	37.4	71.5	486	486
12	K3368-G154(C)(Ex)	41.0	37.4	71.5	486	486
13	K3370-G174(C)(Ex)	50.0	46.1	86.5	528	528

Standard- and Explosion-proof model – Dry well installation

Curve No.	Pump type	Motor input P ₁ (kW)	Motor output P ₂ (kW)	Rated current I _N (A)	Weight standard (kg)	Weight Ex (kg)
1	K3352-PU94(Ex)	17.0	14.6	28.8	224	236
2	K3354-PU94(Ex)	17.0	14.6	28.8	224	236
3	K3356-PU104(Ex)	22.0	19.3	39.1	244	256
4	K3358-PU104(Ex)	22.0	19.3	39.1	244	256
5	K3360-FU124(Ex)	29.0	25.6	51.4	493	493
6	K3362-FU124(Ex)	29.0	25.6	51.4	493	493
7	K3362-FU134(Ex)	33.0	29.2	59.0	503	503
8	K3364-FU134(Ex)	33.0	29.2	59.0	503	503
9	K3364-FU144(Ex)	37.0	33.0	67.1	524	524
10	K3366-FU144(Ex)	37.0	33.0	67.1	524	524
11	K3366-GU154(Ex)	41.0	37.4	71.5	555	555
12	K3368-GU154(Ex)	41.0	37.4	71.5	555	555
13	K3370-GU174(Ex)	50.0	46.1	86.5	610	610



Enclosed two channel impeller
80 mm Ø
Spherical clearance
960 rpm

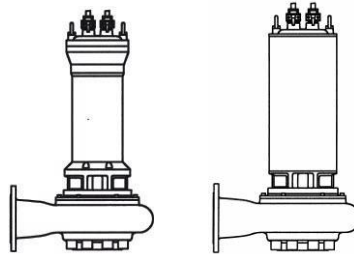

Performance curves

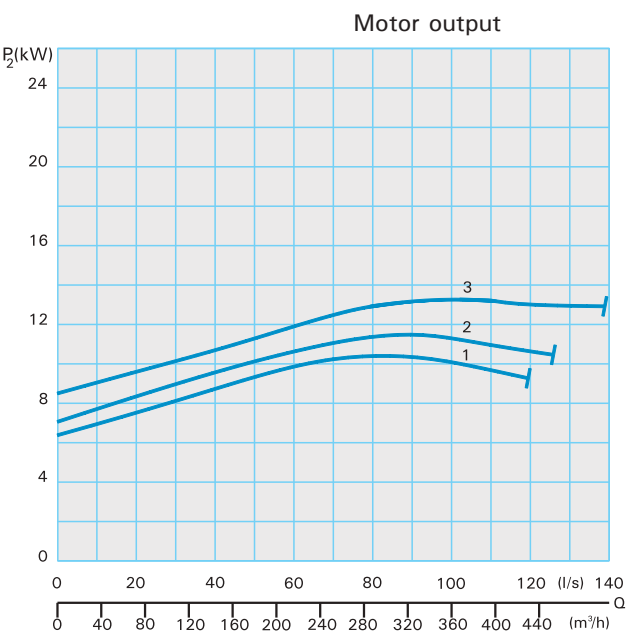
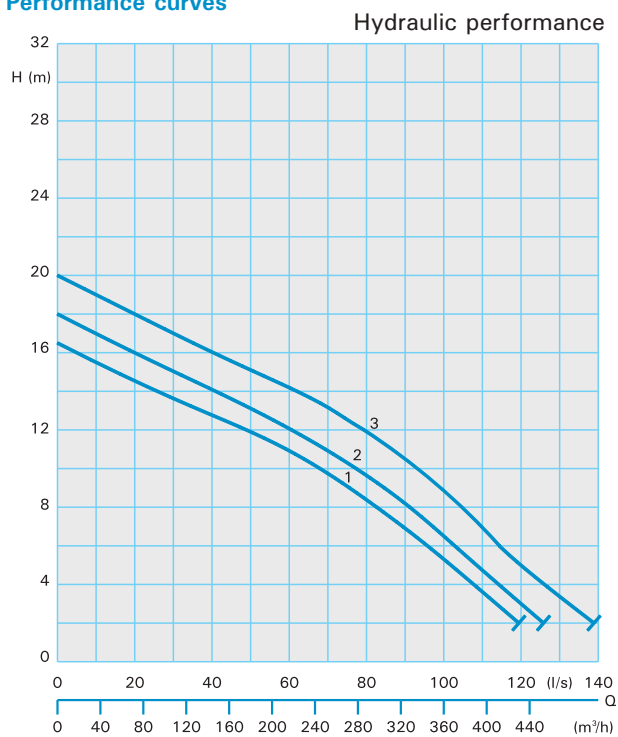

Technical data

Standard- and Explosion-proof model – Wet well installation						
Curve No.	Pump type	Motor input P ₁ (kW)	Motor output P ₂ (kW)	Rated current I _N (A)	Weight standard (kg)	Weight Ex (kg)
1	K3366-P96(C)(Ex)	16.0	13.6	29.4	280	292
2	K3368-P96(C)(Ex)	16.0	13.6	29.4	280	292
3	K3370-P96(C)(Ex)	16.0	13.6	29.4	280	292

Standard- and Explosion-proof model – Dry well installation						
Curve No.	Pump type	Motor input P ₁ (kW)	Motor output P ₂ (kW)	Rated current I _N (A)	Weight standard (kg)	Weight Ex (kg)
1	K3366-PU96(Ex)	16.0	13.6	29.4	288	300
2	K3368-PU96(Ex)	16.0	13.6	29.4	288	300
3	K3370-PU96(Ex)	16.0	13.6	29.4	288	300

DN150 - VX34...-4 pole



Vortex impeller
100 mm Ø
Spherical clearance
1450 rpm

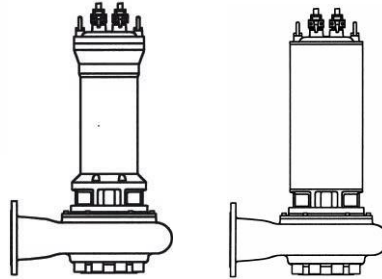

Performance curves

Hydraulic performance

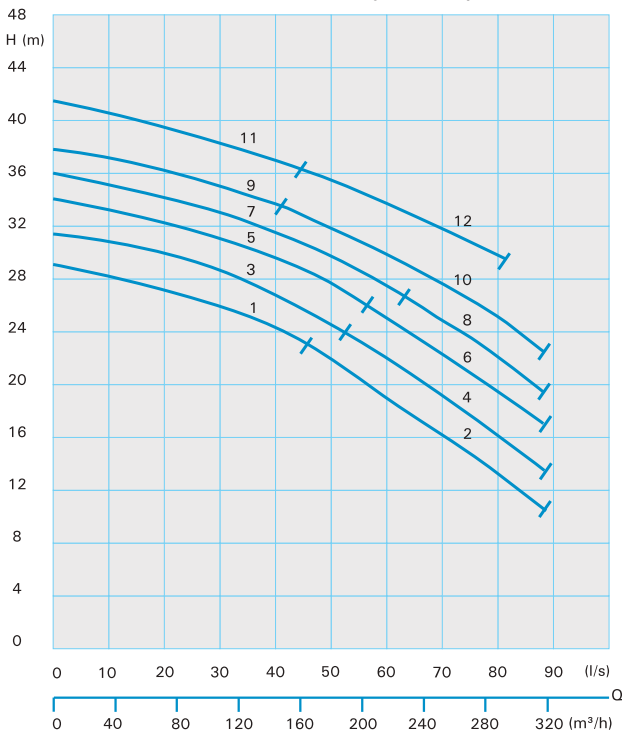

Motor output

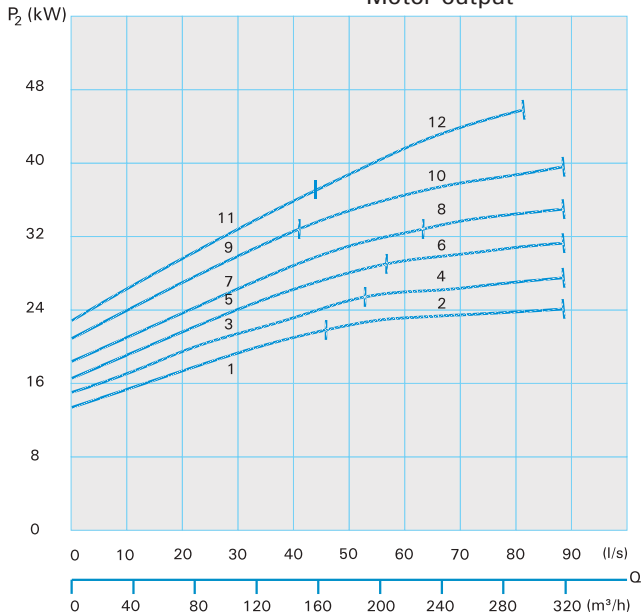

Technical data

Standard- and Explosion-proof model – Wet well installation

Curve No.	Pump type	Motor input P ₁ (kW)	Motor output P ₂ (kW)	Rated current I _N (A)	Weight standard (kg)	Weight Ex (kg)
1	VX3460-F114(C)(Ex)	25.0	22.0	44.0	426	426
2	VX3460-F124(C)(Ex)	29.1	25.6	51.4	448	448
3	VX3463-F124(C)(Ex)	29.1	25.6	51.4	448	448
4	VX3463-F134(C)(Ex)	32.8	29.2	59.0	463	463
5	VX3466-F134(C)(Ex)	32.8	29.2	59.0	463	463
6	VX3466-F144(C)(Ex)	37.1	33.0	67.1	478	478
7	VX3468-F144(C)(Ex)	37.1	33.0	67.1	478	478
8	VX3468-G154(C)(Ex)	41.1	37.4	71.5	495	495
9	VX3470-F144(C)(Ex)	37.1	33.0	67.1	478	478
10	VX3470-G174(C)(Ex)	50.1	46.1	84.3	523	523
11	VX3471-G154(C)(Ex)	41.1	37.4	71.5	495	495
12	VX3471-G174(C)(Ex)	50.1	46.1	84.3	523	523

Standard- and Explosion-proof model – Dry well installation

Curve No.	Pump type	Motor input P ₁ (kW)	Motor output P ₂ (kW)	Rated current I _N (A)	Weight standard (kg)	Weight Ex (kg)
1	VX3460-FU114(Ex)	25.0	22.0	44.0	447	447
2	VX3460-FU124(Ex)	29.1	25.6	51.4	474	474
3	VX3463-FU124(Ex)	29.1	25.6	51.4	474	474
4	VX3463-FU134(Ex)	32.8	29.2	59.0	489	489
5	VX3466-FU134(Ex)	32.8	29.2	59.0	489	489
6	VX3466-FU144(Ex)	37.1	33.0	67.1	504	504
7	VX3468-FU144(Ex)	37.1	33.0	67.1	504	504
8	VX3468-GU154(Ex)	41.1	37.4	71.5	521	521
9	VX3470-FU144(Ex)	37.1	33.0	67.1	504	504
10	VX3470-GU174(Ex)	50.1	46.1	84.3	552	552
11	VX3471-GU154(Ex)	41.1	37.4	71.5	521	521
12	VX3471-GU174(Ex)	50.1	46.1	84.3	552	552



Vortex impeller
100 mm Ø
Spherical clearance
960 rpm

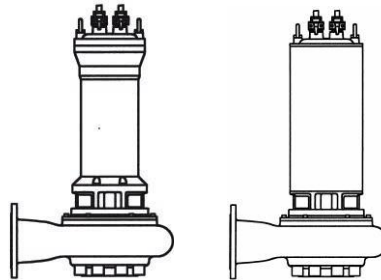

Performance curves

Hydraulic performance

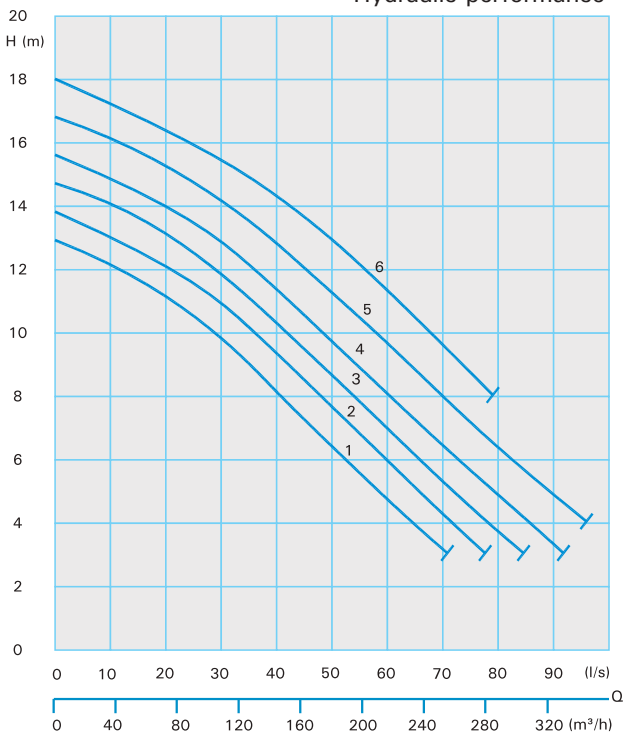

Motor output

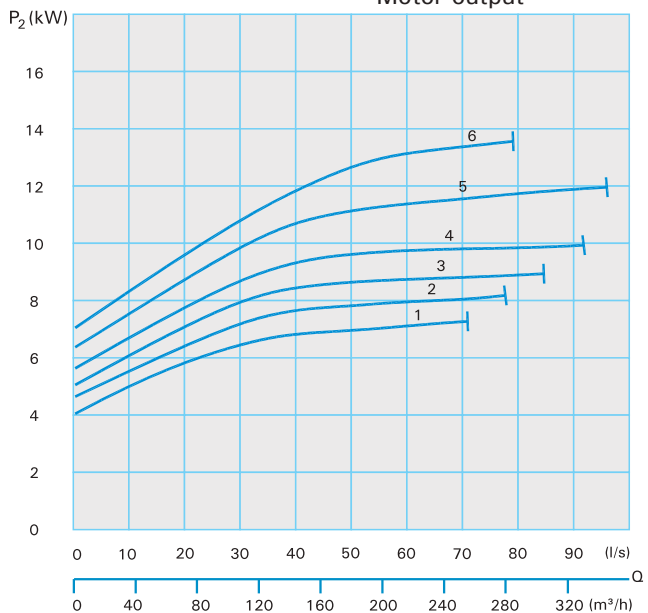

Technical data

Standard- and Explosion-proof model – Wet well installation

Curve No.	Pump type	Motor input P ₁ (kW)	Motor output P ₂ (kW)	Rated current I _N (A)	Weight standard (kg)	Weight Ex (kg)
1	VX3460-P76(C)(Ex)	9.0	7.3	16.3	239	251
2	VX3463-P86(C)(Ex)	12.0	10.0	22.4	264	276
3	VX3466-P86(C)(Ex)	12.0	10.0	22.4	264	276
4	VX3468-P86(C)(Ex)	12.0	10.0	22.4	264	276
5	VX3470-P96(C)(Ex)	16.0	13.6	29.4	278	290
6	VX3471-P96(C)(Ex)	16.0	13.6	29.4	278	290

Standard- and Explosion-proof model – Dry well installation

Curve No.	Pump type	Motor input P ₁ (kW)	Motor output P ₂ (kW)	Rated current I _N (A)	Weight standard (kg)	Weight Ex (kg)
1	VX3460-PU76(Ex)	9.0	7.3	16.3	245	257
2	VX3463-PU86(Ex)	12.0	10.0	22.4	274	286
3	VX3466-PU86(Ex)	12.0	10.0	22.4	274	286
4	VX3468-PU86(Ex)	12.0	10.0	22.4	274	286
5	VX3470-PU96(Ex)	16.0	13.6	29.4	291	293
6	VX3471-PU96(Ex)	16.0	13.6	29.4	291	293

Installations and Dimensions

Pump type	DN1	DN2	DN3	Amax	B	B1	C	C1	D	E	F1	F2	F3	øG	H	
MX1330 to 36-T(U)... 2(Ex)	80	100	R3"AG	759	355	200	307	147	722	97	125	218	316	395	578	
MX1336 to 41-P(U)... 2(Ex)		100	R3"AG	1026	355	200	307	147	712	97	125	218	316	395	578	
MX1344-P(U)122(Ex)		100	R3"AG	1051	459	280	363	165	816	71	125	244	342	395	658	
MX1331 to 36-C24(Ex)		100	R3"AG	517	355	200	307	147	712	97	125	218	316	395	578	
MX1337 to 41-D44(Ex)		100	R3"AG	554	355	200	307	147	722	97	125	218	316	395	578	
MX1331 to 41-TU34(Ex)		100	R3"AG	693	355	200	307	147	712	97	125	218	316	395	578	
MX1337 to 41-TU36(Ex)		100	R3"AG	693	355	200	307	147	712	97	125	218	316	395	578	
MX1344 to 50-T(U)... 4(Ex)		100	R3"AG	791	459	280	363	165	816	71	125	244	342	395	658	
MX1344 to 50-T(U)26(Ex)		100	R3"AG	791	459	280	363	165	816	71	125	244	342	395	658	
V1332 to 39-T(U)... 2(Ex)		100	R3"AG	775	365	220	290	145	722	112	125	203	301	395	598	
V1342 to 46-P(U)... 2(Ex)		100	R3"AG	1035	408	250	316	158	775	112	125	203	301	395	628	
V1334 to 36-C24(Ex)		100	R3"AG	526	365	220	290	145	722	112	125	203	301	395	598	
V1344 to 46-D44(Ex)		100	R3"AG	563	408	250	316	158	775	112	125	203	301	395	628	
V1334 to 36-TU34(Ex)		100	R3"AG	702	365	220	290	145	722	112	125	203	301	395	598	
V1344 to 46-TU34(Ex)		100	R3"AG	702	408	250	316	158	775	112	125	203	301	395	628	
VX1345 to 46-T(U)... 4(Ex)		100	R3"AG	767	408	250	316	158	775	112	125	203	301	395	628	
MX2330 to 36-T(U)... 2(Ex)		100	100	R4"AG	766	355	200	307	147	779	147	125	218	403	395	577
MX2336 to 41-P(U)... 2(Ex)			100	R4"AG	1023	355	200	307	147	779	147	125	218	403	395	577
MX2344-P(U)122(Ex)			100	R4"AG	1051	459	280	363	165	883	122	125	244	429	395	657
MX2346 to 50-F(U)...2(Ex)			100	R4"AG	1270	459	280	382	184	889	121	174	293	478	600	759
MX2331 to 36-C24(Ex)	100		R4"AG	517	355	200	307	147	779	147	125	218	403	395	577	
MX2337 to 41-D44(Ex)	100		R4"AG	554	355	200	307	147	779	147	125	218	403	395	577	
MX2331 to 41-TU34(Ex)	100		R4"AG	691	355	200	307	147	779	147	125	218	403	395	577	
MX2344 to 50-T(U)... 4(Ex)	100		R4"AG	791	459	280	363	165	883	121	125	244	429	395	657	
M(X)2432 to 38-T(U)... 4(Ex)	100		R4"AG	745	422	265	323	147	846	117	125	248	433	395	642	
MX2444 to 48-T(U)... 4(Ex)	100		R4"AG	814	459	280	363	165	883	110	125	255	440	395	657	
MX2452 to 62-P(U)... 4(Ex)	150		R4"AG	1084	576	345	457	207	1000	105	125	260	445	450	755	
MX2436 to 38-T(U)36(Ex)	100		R4"AG	745	422	265	323	147	846	117	125	248	433	395	642	
MX2446 to 48-T(U)36(Ex)	100		R4"AG	814	459	280	363	165	883	110	125	255	440	395	657	
MX2452 to 62-T(U)... 6(Ex)	150		R4"AG	831	576	345	457	207	1000	105	125	260	445	450	755	
V2332 to 39-T(U)... 2(Ex)	100		R4"AG	702	385	240	290	145	799	152	125	213	398	395	617	
V2342 to 46-P(U)... 2(Ex)	100		R4"AG	1035	438	280	316	158	862	152	125	213	398	395	657	
V2334 to 36-C24(Ex)	100		R4"AG	526	385	240	290	145	799	152	125	213	398	395	617	
V2344 to 46-D44(Ex)	100		R4"AG	563	438	280	316	158	862	152	125	213	398	395	657	
V2334 to 36-TU34(Ex)	100		R4"AG	702	385	240	290	145	799	152	125	213	398	395	617	
V2344 to 46-TU34(Ex)	100		R4"AG	702	438	280	316	158	862	152	125	213	398	395	657	
VX2345 to 46-T(U)... 4(Ex)	100		R4"AG	774	438	280	316	158	862	152	125	213	398	395	657	
V2436-T(U)34(Ex)	100		R4"AG	745	422	265	323	147	846	117	125	248	433	395	642	
V2437 to 45-T(U)... 4(Ex)	100		R4"AG	814	459	280	363	165	883	110	125	255	440	395	657	
V2442 to 46-P(U)... 4(Ex)	100		R4"AG	984	459	280	363	165	883	110	125	255	440	395	657	
VX24(36-39)-D54(Ex)	100		R4"AG	630	410	250	296	148	834	140	125	225	410	395	626	
VX24(36-39)-TU44(Ex)	100		R4"AG	731	410	250	296	148	834	140	125	225	410	395	626	
VX24(40-44)-T(U)... 4(Ex)	100		R4"AG	804	460	280	336	168	1029	175	125	225	410	395	657	
VX24(44-46)-P(U)... 4Ex	100		R4"AG	914	460	280	336	168	884	140	125	225	410	395	657	
V2452 to 56-P(U)94(Ex)	150	R4"AG	994	576	345	457	207	1000	105	125	260	445	450	755		
VX24(52-58)-P(U)... 4(Ex)	150	R4"AG	1098	555	345	410	205	979	130	125	235	420	450	749		
K3352 to 58-P(U)... 4(Ex)	150	150	R6"AG	1084	608	370	468	209	1156	140	125	260	546	450	965	
K3360 to 66-F(U)... 4(Ex)		150	R6"AG	1308	753	450	599	268	1302	136	174	313	584	600	1168	
K3366 to 70-G(U)... 4(Ex)		150	R6"AG	1364	753	450	599	268	1302	136	174	313	584	600	1168	
K3366 to 70-P(U)96(Ex)		150	R6"AG	1088	753	450	599	268	1302	136	136	264	535	450	1168	
MX3452 to 62-P(U)... 4(Ex)		150	R6"AG	1084	608	370	468	209	1156	140	125	260	546	450	965	
MX3468 to 74-F(U)... 4(Ex)		150	R6"AG	1201	690	420	547	241	1239	137	174	312	598	600	1077	
MX3456 to 62-T(U)... 6(Ex)		150	R6"AG	831	608	370	468	209	1158	140	125	260	546	450	966	
MX3468 to 74-P(U)... 6(Ex)		150	R6"AG	1016	690	420	547	241	1239	137	125	263	549	450	1047	
VX3460 to 70-F(U)... 4(Ex)		200	R6"AG	1353	620	380	464	232	1170	145	250	380	666	600	1037	
VX3468 to 71-G(U)... 4(Ex)		200	R6"AG	1409	620	380	464	232	1170	145	250	380	666	600	1037	
VX3460 to 71-P(U)... 6(Ex)		200	R6"AG	1133	620	380	464	232	1170	145	250	380	666	600	1037	

J1	J2	K1	K2	K3	K4	L	M	O	P1	P2	Q	Rmax	S1	S3	Tmax	Umax	V1
137	167	148	357	450	615	195	400	687	200	400	93	699	280	95	548	648	260
137	167	148	357	450	615	195	400	687	200	400	93	948	280	95	796	896	310
137	167	148	357	476	641	195	400	767	200	480	119	1063	280	95	886	986	310
137	167																
137	167																
137	167	148	357	450	615	195	400	687	200	400	93	627	280	95	475	575	260
137	167	148	357	450	615	195	400	687	200	400	93	627	280	95	475	575	260
137	167	148	357	476	640	195	400	767	200	480	121	726	280	95	548	648	260
137	167	148	357	476	640	195	400	767	200	480	121	726	280	95	548	648	260
137	167	148	357	435	599	195	400	707	200	420	250	882	360	110	738	843	260
137	167	148	357	435	600	195	400	897	200	450	250	1219	360	110	1075	1180	310
137	167																
137	167																
137	167	148	357	435	600	195	400	707	200	420	250	809	360	110	663	768	260
137	167	148	357	435	600	195	400	737	200	450	250	809	360	110	663	768	260
137	167	148	357	435	600	195	400	737	200	450	250	809	360	110	736	841	260
122	197	148	357	450	645	195	400	727	200	400	93	698	280	95	542	642	260
122	197	148	357	450	645	195	400	727	200	400	93	1035	280	95	883	983	310
122	197	148	357	475	670	195	400	807	200	480	119	1063	280	95	886	986	310
122	197	148	357	475	670	195	400	807	200	480	119	1282	280	95	1087	1187	360
122	197																
122	197																
122	197	148	357	450	645	195	400	727	200	400	93	625	280	95	469	569	260
122	197	148	357	475	670	195	400	807	200	480	118	726	280	95	548	648	260
122	197	148	357	480	674	195	400	792	200	465	123	680	280	95	498	598	260
122	197	148	357	487	681	195	400	807	200	480	130	749	280	95	560	660	260
122	197	205	502	635	830	283	520	883	250	595	135	1096	350	120	902	1012	310
122	197	148	357	480	674	195	400	792	200	465	123	680	280	95	498	598	260
122	197	148	357	487	681	195	400	807	200	480	130	749	280	95	560	660	260
122	196	205	502	637	831	283	520	941	250	595	135	766	350	120	572	682	260
122	197	148	357	445	639	195	400	767	200	440	260	882	360	110	665	770	260
122	197	148	357	445	640	195	400	809	200	480	260	1219	360	110	1075	1180	310
122	197																
122	197																
122	197	148	357	445	639	195	400	767	200	440	260	806	360	110	663	768	260
122	197	148	357	445	639	195	400	807	200	480	260	806	360	110	663	768	260
122	197	148	357	445	639	195	400	807	200	480	260	879	360	110	736	841	260
122	197	148	357	480	674	195	400	792	200	465	123	680	280	95	498	598	260
122	197	148	357	487	681	195	400	807	200	480	130	749	280	95	560	660	260
122	197	148	357	487	681	195	400	807	200	480	130	996	280	95	807	907	310
122	197																
122	197	148	357	457	652	197	400	777	200	450	100	664	280	95	506	601	260
122	197	148	357	457	652	197	400	807	200	480	100	737	280	95	579	674	260
122	197	148	357	457	652	197	400	807	200	480	100	926	280	95	767	862	310
122	197	205	500	637	832	197	520	942	250	595	135	1006	350	120	842	952	310
122	197	205	502	612	806	197	520	941	230	575	110	1110	380	115	941	1046	310
273	273	205	502	637	908	283	520	1076	315	765	139	1096	450	120	902	1012	310
273	273	200	502	641	912	283	560	1191	315	765	139	1323	450	120	1106	1216	360
273	273	200	502	641	912	283	560	1191	315	765	139	1379	450	120	1144	1254	410
273	273	200	502	641	912	283	520	1168	315	765	139	1100	450	120	902	1012	310
273	273	205	502	637	908	283	520	1076	250	620	135	1096	350	120	902	1012	310
273	273	200	502	640	911	283	560	1161	310	730	138	1213	350	90	998	1098	360
273	273	205	502	637	908	283	520	1076	250	620	135	766	350	120	572	682	260
273	273	205	502	640	911	283	520	1126	310	730	138	1028	350	90	831	931	310
273	273	301	692	822	1093	367	560	1121	260	640	130	1365	380	115	1158	1263	360
273	273	301	692	822	1093	367	560	1121	260	640	130	1424	380	115	1197	1302	410
273	273	301	692	822	1093	367	560	1121	260	640	130	1145	380	115	956	1061	310

Installations and Dimensions

Wet well installation with auto-coupling system

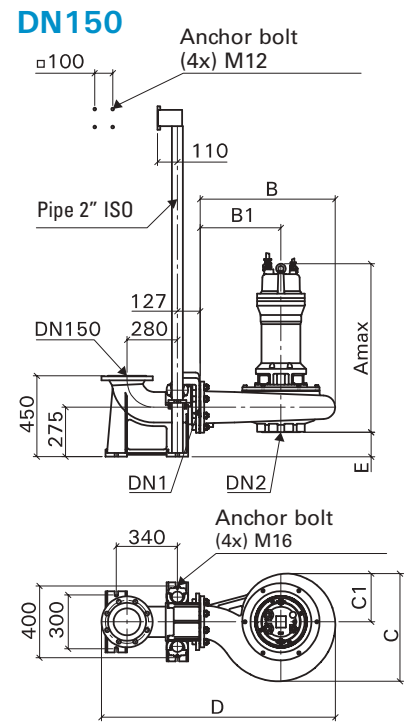
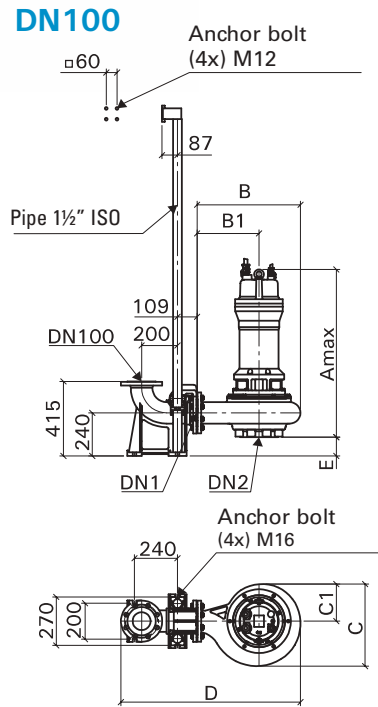
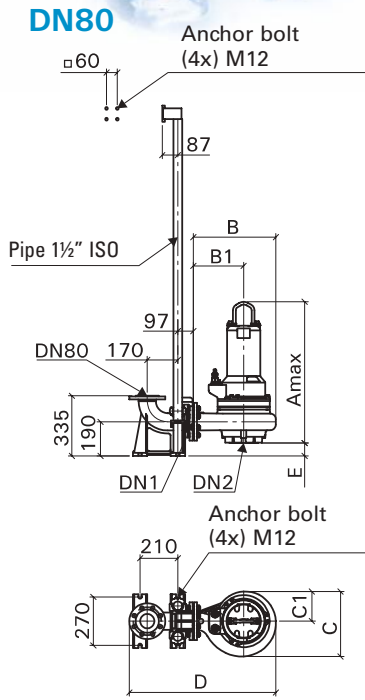

Wet well installation with base stand

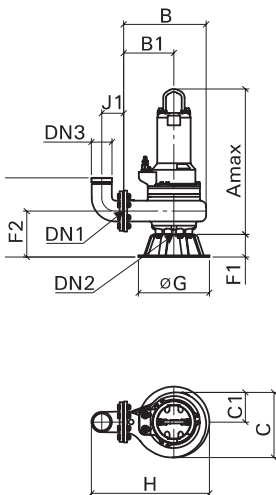

Dry well installation vertical

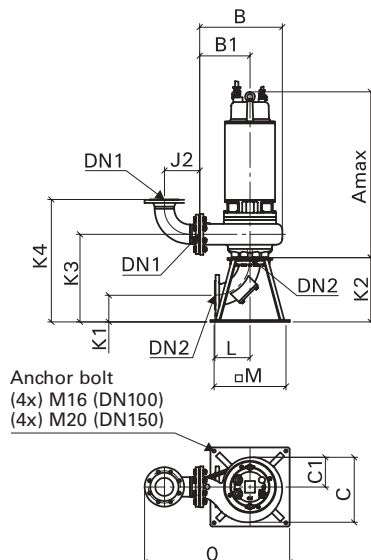

Dry well installation horizontal

Range V13+23/2+4
Separate support flanged to pump housing

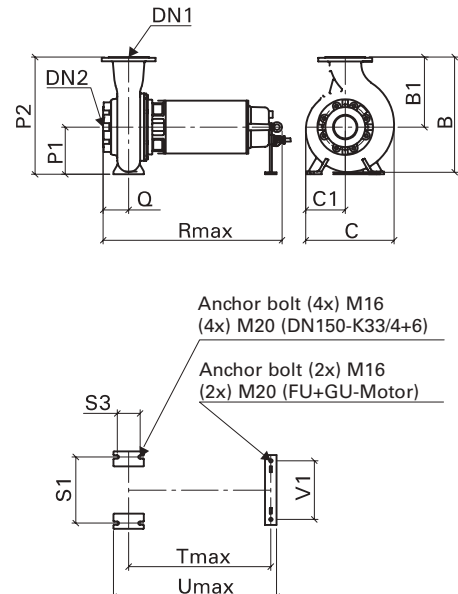

Permanent wet well installation with autocoupling system

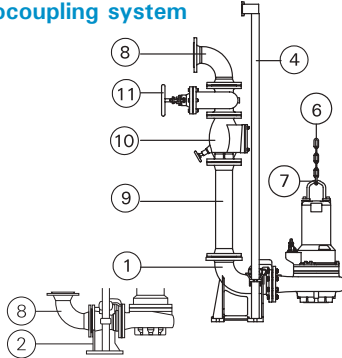

Transportable wet well installation

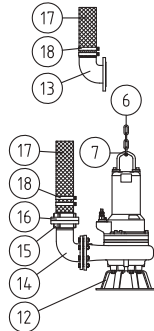

Permanent dry well installation vertical

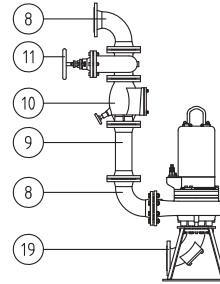

Permanent dry well installation horizontal

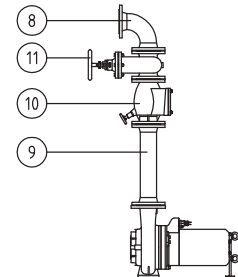

No.	Description	Type	Dimension	Part No.	No.	Description	Type	Dimension	Part No.		
1	Auto-coupling system, cast iron, consisting of auto-coupling with flanged elbow, flanged pump coupling and upper slide rail bracket - Cast iron	KK 80/ 80	DN 80	8604025	10	Flanged swing check valve, cast iron		DN 80	2212807		
		KK 80/100	DN 80/DN100	8604030			DN100	2212809			
		KK 100/100	DN100	8604055			DN125	2212810			
		KK 100/ 80	DN100/DN 80	8604060			DN150	2212811			
		KK 150/150	DN150	8604070			DN200	2212816			
		KK 150/100	DN150/DN100	8603632							
		KK 200/150	DN200/DN150	8604105							
		- Cast iron, upper slide-rail bracket Stainless Steel	KKR 80/ 80	DN 80		8604026	11	Flanged gate valve, cast iron		DN 80	2216080
			KKR 80/100	DN 80/DN100		8604031			DN100	2216100	
			KKR 100/100	DN100		8604056			DN125	2216125	
KKR 100/ 80	DN100/100		8604061	DN150	2216150						
KKR 150/150	DN150	8604071		DN200	2216200						
KKR 150/100	DN150/100	8604073									
KKR 200/150	DN200/150	8604106									
- complete Stainless Steel	KKC 80/ 80	DN 80	8604027	12	Ring base stand up to 16,9 kW (P2) from 17,0 kW (P2)	NB 100 A	DN100	7321215			
	KKC 100/100	DN100	8604057			NB 150 A	DN150	7321285			
	KKC 150/150	DN150	8604072			NB 150	DN150	7321275			
2	Auto-coupling system consisting of auto-coupling with horizontal discharge flange, flanged pump coupling and upper slide rail bracket	KS 80/ 100	DN 80/DN100	8604045	13	Flanged spigot elbow with gasket and fixing bolts		DN100/110mm	6001141		
		KS 100/100	DN100	8604065							
		KS 150/150	DN150	8604075							
		KS 200/150	DN 200/DN150	8604083							
		Intermittent slide rail bracket		1 ½" for DN 80			7322901				
- Cast iron		1 ½" for DN100	7322931								
		2" for DN150	7320121A								
		2 ½" for DN200	7322911								
- Stainless steel			1 ½" for DN 80	7323854A	14	90° Flanged elbow Double nipple Threaded flange Flanged to thread elbow with gasket and fixing bolts		BSP3"F/M	2111805		
			1 ½" for DN100	7320355A				BSP3"F	2128030		
			2" for DN150	7323974A				DN80/BSP3"F	2215080		
			2 ½" for DN200					DN100xBSPP4"M DN150xBSPP6"M	6001121 6001205		
4	Guide rails, pair, per meter - Galvanized steel		1 ½" for DN80/100	2190155	15	STORZ-fixed coupling		B-BSP3"M	2010603		
			2" for DN150	2190205				B-BSP3"F	2010602		
			2 ½" for DN200	2190225				A-BSP4"F	2010701		
								F-BSP6"F	2010961		
- Stainless steel			1 ½" for DN80/100	2190254	16	STORZ-hose coupling with spigot		B-75 mm	2013502		
			2" for DN150	2190256				A-110 mm	2013801		
			2 ½" for DN200	2190258				F-150 mm	2013901		
								A - B	2015612		
						F - A	2015622				
6	Lifting chain, Galvanized steel, per meter		5 mm Ø	2800350	17	Reinforced hose, per m (inner dia. in mm)		75 mm	2632075		
			8 mm Ø	2800380				110 mm	2632110		
			10 mm Ø	2800410				150 mm	2632150		
Stainless steel AISI316 (A4), per meter			8 mm Ø	2800384	Hose with pre-attached couplings			on request			
			10 mm Ø	2800386							
7	Galvanized steel shackle		f. 5 mm Ø	2801450	18	Hose bands		S 85/20	2308520		
			f. 8 mm Ø	2801380				S100/20	2310020		
			f. 10 mm Ø	2801410				S115/20	2311520		
								S118/20	2311820		
Stainless steel shackle AISI316 (A4)			f. 8 mm Ø	2801384		S172/20	2317520				
			f. 10 mm Ø	2801386							
8	90° flanged elbow		DN 80	2153302	19	Flanged pump stand with gasket and fixing bolts	TVS 100 A (up to 28kW)	DN100	7321705		
			DN 100	2153303			TVS 150 A	DN150	7321725		
			DN 150	2153353							
			DN 200	2153363							
or flanged y-piece for twin pump arrangement, horizontal discharge (optional with vertical discharge) with gasket and fixing bolts		DN 80/ 80/ 80	on request		Pump stand with suction elbow, cleaning hole, gasket and fixing bolts	TVS 100 A-R (up to 28kW)	DN100	8604220			
		DN 80/ 80/100				TVS 100 A-R	DN100	8604221			
		DN 100/100/100				TVS 150 A-R	DN150	8604225			
		DN 100/100/125				TVS 150-R	DN150	8604230			
		DN 100/100/150				TVS 150/200 A-R	DN150/DN200	8604232			
		DN 150/150/150				TVS 150/200-R	DN150/DN200	8604235			
		DN 200/200/200									
9	Flanged discharge pipe, 1 m, with gasket and fixing bolts		DN 80	2152081	Screw kit with gaskets Gavanized steel		DN 80	2214080			
			DN 100	2152201			DN100	2214100			
			DN 125	2152221			DN150	2214150			
			DN 150	2152251		Stainless steel		DN 80	2214082		
			DN 200	2152271				DN100	2214102		
				DN150	2214152						
Discharge pipe, per additional meter			DN 80	2150180	Flanged reducer		on request				
			DN 100	2150100							
			DN 125	2150125							
			DN 150	2150150							
			DN 200	2150200							

Stainless steel pipes, fittings on request.

Electrical or electronic control panels for pumps and pump stations with accessories on request.

Sumps of concrete or synthetic material for complete pump stations please see special leaflet.



HOMA Product Range

- Submersible waste water pumps
- Deep-well submersible pumps
- Submersible sewage pumps
- Submersible grinder pumps with cutter system
- Waste water disposal units
- Sewage disposal units
- Packaged pump stations
- Mixers and flow generators
- Injector systems for tank cleaning
- Garden pumps and domestic booster units
- Control boxes



Worldwide Presence

HOMA pumps are installed in more than 60 countries around the world – in countless projects of various kinds. They comply to all international safety and quality standards and are certified by many institutions and organisations responsible for national waste water treatment standards. To maintain and further develop this high quality level is our main target.



Network of Sales and Service Partners

HOMA provides a worldwide network of agents and distributors supporting our customer with excellent sales and service assistance in planning, specification and selection, including a computer software program available on CD-ROM or from the WorldWide-Web.

HOMA Pumpenfabrik GmbH

P.O. Box 22 63 ➤ 53819 Neunkirchen-Seelscheid; Germany

Phone +49 (0)22 47 /702-0 ➤ Fax +49 (0) 22 47/702-44

e-mail: info@homa-pumpen.de ➤ Internet: www.homapumps.com

